



ROHDE&SCHWARZ

Test and Measurement
Division

Operating Manual

SIGNAL GENERATOR

SMG

801.0001.52

Printed in the Federal
Republic of Germany

Certified Quality System ISO 9001

DQS REG. NO 1954-02

Qualitätszertifikat

Sehr geehrter Kunde,

Sie haben sich für den Kauf eines Rohde & Schwarz-Produktes entschieden. Hiermit erhalten Sie ein nach modernsten Fertigungsmethoden hergestelltes Produkt. Es wurde nach den Regeln unseres Qualitätsmanagementsystems entwickelt, gefertigt und geprüft. Das Rohde & Schwarz-Qualitätsmanagementsystem ist nach ISO 9001 zertifiziert.

Certificate of quality

Dear Customer,

You have decided to buy a Rohde & Schwarz product. You are thus assured of receiving a product that is manufactured using the most modern methods available. This product was developed, manufactured and tested in compliance with our quality management system standards.

The Rohde & Schwarz quality management system is certified according to ISO 9001.

Certificat de qualité

Cher client,

Vous avez choisi d'acheter un produit Rohde & Schwarz. Vous disposez donc d'un produit fabriqué d'après les méthodes les plus avancées. Le développement, la fabrication et les tests respectent nos normes de gestion qualité.

Le système de gestion qualité de Rohde & Schwarz a été homologué conformément à la norme ISO 9001.



ROHDE & SCHWARZ

Safety Instructions

This unit has been designed and tested according to the standards outlined overleaf and has left the manufacturer's premises in a state fully complying with the safety standards.

In order to maintain this state and to ensure safe operation, observe the following instructions, symbols and precautions.

- 1) When the unit is to be permanently cabled, first connect protective ground conductor before making any other connections.
- 2) Built-in units should only be operated when properly fitted into the system.
- 3) For permanently cabled units without built-in fuses, automatic switches or similar protective facilities, the AC supply line shall be fitted with fuses rated to the units.
- 4) Before switching on the unit ensure that the operating voltage set at the unit matches the line voltage.
If a different operating voltage is to be set, use a fuse with appropriate rating.
- 5) Units of protection class I with disconnectible AC supply cable and plug may only be operated from a power socket with protective ground contact.
The protective ground connection should not be made ineffective by an extension cable.
Any breaking of the protective ground conductor within or outside of the unit or loosening of the protective ground connection may cause the unit to become electrically hazardous.
The protective ground conductor shall not be interrupted intentionally.
- 6) Before opening the unit, isolate it from the AC supply.
Adjustment and replacement of parts as well as maintenance and repair should be carried out only by specialists approved by R & S.
Observe safety regulations and rules for the prevention of accidents.
Use only original parts for replacing parts relevant to safety (e.g. power on/off switches, power transformers or fuses).
- 7) Also observe the additional safety instructions specified in this manual.

Explanation of Symbols Used



- Read operating manual, observe the safety symbols used



- Caution, shock hazard



- Protective ground connection



- Unit ground



- Equipotential (floating ground)



- Ground



ROHDE & SCHWARZ
EC Certificate of Conformity



Certificate No.: 9502164

This is to certify that:

Equipment type	Order No.	Designation
SMG-B1	0802.0005.02	Reference Oscillator OCXO
SMG-B2	0802.0405.02	AF Synthesizer
SMG-B3	0801.9609.02	X Output

complies with the provisions of the Directive of the Council of the European Union on the approximation of the laws of the Member States

- relating to electromagnetic compatibility
(89/336/EEC revised by 91/263/EEC, 92/31/EEC)

Conformity is proven by compliance with the following standards:

EN50081-1 : 1992
EN50082-1 : 1992

Affixing the EC conformity mark as from 1995

ROHDE & SCHWARZ GmbH & Co. KG
Mühldorfstr. 15, D-81671 München

Munich, 27.11.95

Central Quality Management FS-QZ / Becker

Contents of SMG Manual

Operating Manual

1. Data Sheet
2. Preparation for Use and Operating Instructions
3. Maintenance

Service Manual

4. Service Manual for Complete Instrument
5. Service Instructions for the Individual PC Boards

	Order No.	Index
Keyboard/Display	801.1366.02	1
FRN Loop	801.3917.02	2
RF Oscillator	801.5110.02	3
Output Stage	801.3217.02	4
Processor	801.2410.02	5
AF Generator	801.7312.02	6
Power Pack	801.1614.02	7
RF Attenuation Set	801.1108.02	8
Reference Oscillator, OCXO (Option SMG-B1)	802.0005.02	9
AF Synthesizer (Option SMG-B2, B21)	802.0405.02	10
X Output (Option SMG-B3)	801.9609.02	10

Table of Contents

		Page
<u>1</u>	<u>Data Sheet</u>	
<u>2</u>	<u>Preparation for Use and Operation</u>	
2.1	Legend to Front and Rear Views Figs 2-1 and 2-2	2.1
2.2	Preparation for Use	2.5
2.2.1	Power Supply Fuse	2.5
2.2.2	AC Power Supply	2.5
2.2.3	Rack Mounting	2.5
2.3	Operation	2.6
2.3.1	Status Upon Switching On	2.13
2.3.2	Internal/External Reference Frequency	2.14
2.3.3	Frequency (RF)	2.16
2.3.4	Frequency Offset (RF OFFSET)	2.17
2.3.5	Level	2.19
2.3.6	Level Offset	2.20
2.3.7	Non-interrupting Level Setting	2.21
2.3.8	Level Control Without Function	2.22
2.3.9	Level EMF	2.22
2.3.10	Internal AF Modulation Frequency	2.23
2.3.11	AF Amplitude	2.25
2.3.12	Modulation, AM	2.27
2.3.13	Modulation, FM	2.29
2.3.14	Modulation, ϕ M	2.31
2.3.15	Modulation, FSK	2.33
2.3.16	Pulse Modulation, PM	2.34
2.3.16.1	Pulse Modulation (Code 29)	2.34
2.3.16.2	Pulse Modulation with Level Control Voltage from Table	2.34b
2.3.16.3	Pulse Modulation (Code 19)	2.34c
2.3.17	Modulation, External Source	2.35
2.3.18	Modulation, Two-tone	2.37
2.3.19	Variation, Rotary Knob	2.38
2.3.20	Rotary Knob, Step Size	2.40
2.3.21	Variation, HOLD	2.41
2.3.22	Variation, Δ REF	2.41
2.3.23	Variation, Step	2.42

	Page
2.3.24	Sweep (RF) 2.44
2.3.25	Sweep (RF), Parameter Entry 2.44
2.3.26	Sweep (RF), Operating Modes 2.46
2.3.27	Sweep (RF), Display 2.48
2.3.28	Sweep (RF), Logarithmic 2.49
2.3.29	Sweep (AF) 2.50
2.3.30	Sweep (AF), Parameter Entry 2.50
2.3.31	Sweep (AF), Operating Modes 2.51
2.3.32	Sweep (AF), Display 2.52
2.3.33	Sweep (AF), Logarithmic 2.52
2.3.34	Sweep (RF, AF), X Output and Z Output 2.52
2.3.35	Store - Recall 2.53
2.3.36	Sequence 2.54
2.3.37	Special Functions 2.57
2.3.38	Self-test 2.60
2.3.39	Status 2.60
2.3.40	Instrument Preset 2.64
2.3.41	IEC-bus Address 2.65
2.4	Remote Control of Instrument via IEC Bus 2.66
2.4.1	Interface Description 2.66
2.4.2	Setting the Device Address 2.69
2.4.3	Local/Remote Switchover 2.69
2.4.4	Interface Messages 2.70
2.4.4.1	Universal Commands 2.70
2.4.4.2	Addressed Commands 2.71
2.4.5	Device Messages 2.73
2.4.5.1	Commands Received by the SMG in Listener Mode ... 2.73
2.4.5.2	Messages Transmitted by SMG in Talker Mode 2.77
2.4.5.3	Common Commands 2.80
2.4.5.4	Device-specific Commands 2.83
2.4.5.5	Alternatives for the Command Syntax 2.97
2.4.6	Service Request and Status Register 2.98
2.4.7	Timing of Command Processing and Synchronization 2.104
2.4.8	Error Handling 2.106
2.4.9	Resetting Device Functions 2.107
2.5	Options 2.108

Contents

	Page
<u>3</u>	<u>Maintenance</u>
3.1	Required Measuring Equipment and Accessories 3.1
3.2	Testing the Performance Data 3.3
3.2.1	Display and Keyboard 3.3
3.2.2	Frequency Setting 3.3
3.2.3	Reference Frequency 3.3
3.2.4	Settling Time 3.4
3.2.5	Output Level 3.5
3.2.6	Attenuation Set 3.5
3.2.7	Non-interrupting Level Setting 3.6
3.2.8	Output Reflection Coefficient 3.6
3.2.9	Harmonics 3.7
3.2.10	Spurious 3.8
3.2.11	SSB Phase Noise 3.8
3.2.12	Broadband Noise 3.10
3.2.13	Residual FM 3.11
3.2.14	Modulation Generator 3.12
3.2.15	Function Test of the External Modulation Level Monitoring 3.12
3.2.16	AM Modulation Depth 3.13
3.2.17	AM Distortion 3.13
3.2.18	AM Frequency Response 3.13
3.2.19	AM DC 3.14
3.2.20	Residual AM 3.14
3.2.21	Incidental ϕ M at AM 3.14
3.2.22	FM Deviation Setting 3.15
3.2.23	FM Distortion 3.15
3.2.24	FM Frequency Response 3.15
3.2.25	Frequency Offset at FM DC 3.15
3.2.26	Incidental AM at FM 3.16
3.2.27	ϕ M Deviation Setting 3.16
3.2.28	ϕ M Distortion 3.16
3.2.29	ϕ M Frequency Response 3.17
3.2.30	Overvoltage Protection 3.17
3.2.31	Pulse Modulation 3.17
3.3	Performance Test Report 3.18





2 Preparation for Use and Operation



The values specified in this section are not guaranteed; only the specifications of the data sheet are binding.



All underlined numbers refer to the items of front and rear views Figs. 2-1 and 2-2 in the Appendix.

2.1 Legend to Front and Rear Views Figs 2-1 and 2-2

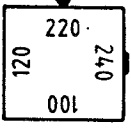
No.	Label	Function
<u>1</u>	FREQUENCY	RF display. Further information in section 2.3, Operation.
<u>2</u>	PARAMETER ON/OFF	The PARAMETER ON/OFF keypad is used to set the parameter to which numerical entries and variations then apply. Parameters can be switched on or off using the ON/OFF keys. Further information in section 2.3, Operation.
<u>3</u>	MODULATION	Display of the modulation depth, deviation and AF. Further display functions in section 2.3, Operation.
<u>4</u>	DATA ENTER/UNITS	Numerical keypad for the parameter set in the PARAMETER keypad. Further information in section 2.3, Operation.
<u>5</u>	AMPLITUDE	Display of the RF or AF level. Further display functions in section 2.3, Operation.

No.	Label	Function
<u>6</u>	VARIATION	Keypad to vary the parameter set in the PARAMETER keypad using the rotary knob or the STEP $\uparrow\downarrow$ keys. Further information in section 2.3, Operation.
<u>7</u>	SWEEP	Keypad to select the operating mode and to switch the sweep on and off. Further information in section 2.3, Operation.
<u>8</u>	 AF INT	BNC output of internal AF signal; level adjustable with SMG-B2 AF synthesizer option. Further information in sections "Internal AF Modulation Frequency" and "AF Amplitude".
<u>9</u>	 AM EXT  FM/ ϕ M EXT	BNC inputs for external modulation signals. Input impedance 100 k Ω (600 Ω). Further information in section "Modulation, External Source".
<u>10</u>	POWER	Power switch
<u>11</u>	 RF 50 Ω	RF output, N socket 50 Ω .
<u>12</u>	LOCAL IEC ADDR	Key for switching to manual operation and for entry or display of IEC-bus address. Further information in section "IEC-bus Address".

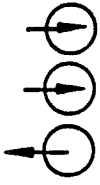
No.	Label	Function
<u>13</u>	REMOTE	LED to indicate the remote state.
<u>14</u>	SHIFT	Key to select the SHIFT functions. Further information in section 2.3, Operation.
<u>15</u>	STATUS INSTR PRESET	Key for status check or for instrument preset. Further information in sections "Status " and "Instrument Preset".
<u>16</u>	MEMORY	Keypad to store instrument settings, to call stored settings and for the sequence function. Further information in section "Store - Recall" and "Sequence".
<u>17</u>	Option SMG-B1 Reference Oscillator Option SMG-B2 AF Synthesizer Option SMG-B3 X Output	The instrument is fitted with options as given by the adhered labels.
<u>18</u>	100/120 V T 2.0 D 220/240 V T 1.6 D	Fuse values for the different AC power supplies.
<u>19</u>		Fuse holder and power supply selector.
<u>20</u>	 47...63 Hz	Power supply connection.

No.	Label	Function
<u>21</u>	 <p>AM EXT (X-Axis) FM/φM EXT (Z-Axis) AF INT</p>	<p>3 cut-outs provided either for fitting the corresponding front panel sockets to the rear panel or for accommodating the sockets X-Axis and Y-Axis if the X Output option SMG-B3 is fitted.</p>
<u>22</u>	 <p>REF FREQ 10 MHz</p>	<p>Output of the internal reference frequency (level 0 dBm) with an internal reference. Input of the external reference frequency (level >100 mV sine wave or TTL) with an external reference. The input or output frequency can be selected as 5 MHz or 10 MHz using an internal jumper. Further information in section "Internal/External Reference Frequency".</p>
<u>23</u>	<p>IEC 625 IEEE 488</p>	<p>IEC-bus connector for remote control.</p>
<u>24</u>	 <p>RF 50 Ω</p>	<p>Cut-out provided for fitting the front panel RF output to the rear panel.</p>
<u>25</u>	<p>PM EXT</p>	<p>BNC input for pulse modulation (TTL input). If the TTL signal is at LOW level, the RF level is blanked. For further information, see section "Modulation, PM".</p>

2.2 Preparation for Use

2.2.1 Power Supply Fuse

The power supply fuse is located in the holder 19 (Figs. 2-2 and 2-3). The value of the fuse for different power supplies can be obtained from the label 18 (Fig. 2-2). The fuse holder can be removed by inserting a screwdriver into the cut-out on the right.

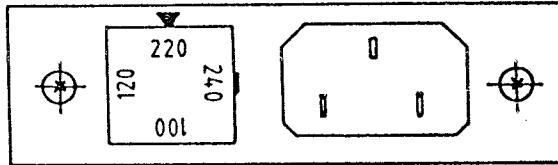

Fig. 2-3 Power supply plug, voltage selector and fuse holder

2.2.2 AC Power Supply

The SMG can be used with power supplies of 100 V, 120 V, 220 V and 240 V. Check that the voltage selector is set to the correct supply before using the instrument. To adjust to the local supply, insert the required fuse, insert the fuse holder again and rotate until the value of the power supply is at the top underneath the arrow.

A fuse type T 2.0 D is required for 100 V and 120 V and type T 1.6 D for 220 V and 240 V.

2.2.3 Rack Mounting

The SMG can be fitted into any 19" rack using the 19" adapter ZZA-93 (Ord. No. 396.4892.00).

When fitting into a rack, ensure that the air inlet through the perforations in the side panels and the air outlet at the rear are not impeded.

Fitting instructions are included with the 19" adapter.

2.3 Operation

The signal generator SMG outputs signals between 100 kHz and 1000 MHz at the RF output in a level range from 13 dBm (16 dBm) to -140.1 dBm with AM, PM, FM or ϕ M. Two-tone modulation is also possible as well as simultaneous AM and FM or AM and ϕ M. The output signal may be set at a fixed frequency or swept.

A signal in the frequency range from 10 Hz to 100 kHz with an amplitude range from 1 mV to 1 V (V_{RMS}) is available at the AF output if the SMG is fitted with the option AF Synthesizer SMG-B2.

The SMG can be set via the keyboard, rotary knob and the IEC-bus interface.



Fig. 2-4 SMG front panel

Selection of parameters

The **PARAMETER ON/OFF** keypad 2 is used to set the parameter for which numerical entries and variations then apply. The set parameter is indicated by an LED. Only one parameter can be set at a time. The only exception is the **STEP** parameter which can be set at the same time as another parameter (to enter the step size for the **STEP** function).

The **SHIFT** parameters (blue label) f_{START} , f_{STOP} , f_{STEP} , **TIME/STEP**, **RF OFFSET**, **LEVEL OFFSET** and **SPECIAL** are set by pressing the **SHIFT** key 14 before the parameter key.

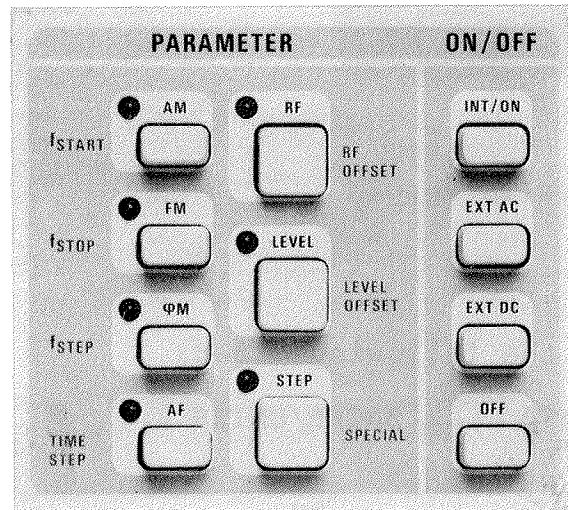

Fig. 2-5 PARAMETER ON/OFF keypad

Switching the parameters on and off

Parameters which can be switched on and off are AM, FM, ϕ M, AF, LEVEL, RF, OFFSET and LEVEL OFFSET.

The parameters are switched on by pressing the parameter key and then one of the three ON keys (INT/ON, EXT AC, EXT DC) in the parameter keypad. The parameters are then switched to the stored value of the last setting.

The parameters can also be switched to numerical entry using one of the ENTER/UNITS keys. If the data input is then omitted, the parameter is set again to the stored value of the last setting.

The parameters are switched off by pressing the parameter key and then the OFF key in the ON/OFF key column of the parameter field.

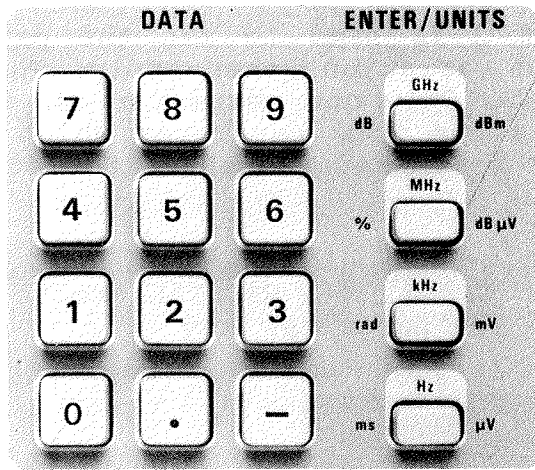

Fig. 2-6 DATA and ENTER/UNITS keypad

Numerical entry

A value can be entered in the following order:

PARAMETER — DATA — ENTER/UNITS

Example: RF 1 MHz

The parameter need not be set again for further entries once it has been set (parameter LED on). This does not apply to the SHIFT parameters (blue label) f_{START} , f_{STOP} , f_{STEP} , TIME/STEP, RF OFFSET, LEVEL OFFSET and SPECIAL which only remain set for one entry.

The value is set by pressing one of the ENTER/UNITS keys.

Numerical entries must always be terminated by pressing one of the ENTER/UNITS keys. Any of the four ENTER/UNITS keys can be used for parameters without a unit.

Example:

		DATA		ENTER/UNITS
Call memory location setting 5	RCL <input type="text"/>	<input type="text" value="5"/>		<input type="text"/>
Switch on special function AF amplitude	SHIFT <input type="text"/>	<input type="text"/>	SPECIAL	<input type="text" value="5"/>

Correction of entry

An entered value can be cleared before being set (i.e. before pressing one of the ENTER/UNITS keys) by pressing the key of the set parameter (LED on) or one of the other parameters.

The SHIFT function (set by pressing the SHIFT key) can be cleared by pressing the SHIFT key again.

Changing the unit

In order to change the displayed unit of a parameter, set the parameter in the parameter keypad and press the required unit in the ENTER/UNITS column.

For example, if the level is displayed in mV and is to be displayed in dBm, proceed as follows:

PARAMETER	ENTER/UNITS
LEVEL	
<input type="checkbox"/>	<input type="checkbox"/> dBm

The parameter key need not be pressed again if the parameter is already set (LED on).

Displays

The RF is output with up to 10 digits in the **FREQUENCY** display 1.

The following are also output in this display:

- sweep parameters,
- step size for STEP variation of RF,
- frequency offset,
- memory sequence,
- status codes of the set special functions,
- the note A L C - C A L I b r during execution of the "calibration routine for level control voltage from table"
- external reference mode and
- IEC-bus address.

The following are output in the **MODULATION** display 3:

- type of modulation switched on,
- modulation depth and deviation,
- AF,
- step sizes for the STEP variation of the modulation parameters and AF,
- status codes of function errors, input errors and overrange/underrange settings,
- reference LOW or HIGH if the external modulation voltage is not equal to 1 V (V_{RMS}).

The following are output in the **AMPLITUDE** display 5:

- level of the RF or AF output,
- step size for the STEP variation of the RF or AF level,
- level offset,
- value of the non-interrupting level setting,
- memory location called in sequence mode,
- measured values of internal test points (self-test) and
- reference OVERLOAD if the RF output is externally overloaded and
- reference **OP. 1.2.3** depending on the options fitted.

Display of the SHIFT parameters

The SHIFT parameters (blue label) are output in the corresponding display as long as the parameter key is kept pressed following subsequent stroking of the SHIFT key.

Display of entered numerical value

During entering a numerical value (DATA keys), the digits of the newly entered value are correspondingly output in the display of the related parameter.

Variation

The parameters AM modulation depth, FM deviation, Φ M deviation, AF, RF and LEVEL can be varied. The SHIFT parameters cannot be varied.

The parameter currently set in the parameter keypad can be varied using the STEP $\uparrow\uparrow$ keys in the variation keypad 6.

The parameter set in the parameter keypad can also be varied using the rotary knob unless the HOLD function or MAN SWEEP is set.

The variation using the STEP $\uparrow\uparrow$ keys can be made in individual steps or repeatedly, first slowly and then faster, by pressing the key continuously. Further information in sections "Variation".

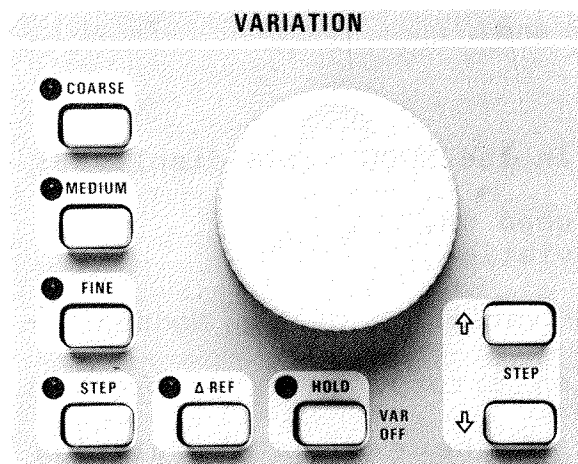

Fig. 2-7 VARIATION keypad

Sweep

The generator provides a staircase sweep with an adjustable step size for the RF and, if fitted with the option AF synthesizer SMG-B2, also for the AF.

The sweep parameters (SHIFT parameters) f_{START} , f_{STOP} , f_{STEP} , TIME/STEP are defined by numerical entries.

The sweep is switched on and off and the mode selected using the keys in the SWEEP keypad 7. Further information in sections "Sweep".

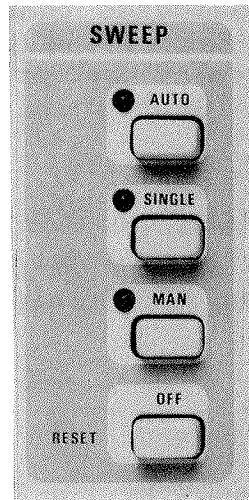

Fig. 2-8 SWEEP keypad

Store - recall

The generator can store settings which can later be recalled. This function is accessed using the keys in the MEMORY keypad 16. Further information in sections "Store - Recall" and "Sequence".

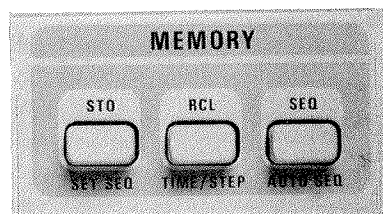

Fig. 2-9 MEMORY keypad

Special functions

Special functions extend the settings indicated by the labelling of the keys. Further information in section "Special Functions".

Status

Input errors are indicated in the modulation display by brief output of the status code identifying the error and flashing of the STATUS LED.

Function errors are indicated by continuous flashing of the STATUS LED. The status code describing the error appears in the modulation display when the STATUS key is pressed.

Overrange/underrange settings are indicated by continuous lighting up of the STATUS LED. The status code describing the setting appears in the modulation display when the STATUS key is pressed.

Continuous lighting up of the STATUS LED indicates that a special function is switched on. The status code describing the special function is output in the frequency display by pressing the STATUS key. Further information in section "Status".

IEC-bus address

The IEC-bus address can be output in the frequency display and set via the keyboard. Further information in section "IEC-bus Address".

Instrument preset

The generator is set to a defined basic status by the key sequence SHIFT - INSTR PRESET. Further information in section "Instrument Preset".

2.3.1 Status Upon Switching On

The generator has the same status when switched on as before switching off.

Exceptions:

- + Local mode is always set
- + An SRQ can be output on the IEC bus each time the instrument is switched on
- + Auto sequence is switched off
- + For setting the registers of the service request function, see sections "Service Request and Status Registers" and "Resetting Device Functions".

A function test is carried out following switch-on. The ROM and RAM contents are checked. The LED of the STATUS key flashes if an error is detected. The associated status display is output in the modulation display by pressing the STATUS key.

The preset status is set if the status prior to switch-off cannot be set again because of a memory error.

Display: Following switch-on, the set IEC-bus address is briefly output in the frequency display and the information on the options fitted (SMG-B1, SMG-B2, SMG-B3) in the amplitude display.

OP. 1.2.3

2.3.2 Internal/External Reference Frequency

The internal standard reference source of the SMH is a 50-MHz crystal oscillator. Higher requirements with respect to frequency accuracy are satisfied by the option Reference Oscillator SMG-B1, OCXO. Subsequent fitting of this option is described in section "Options".

In internal reference mode, the internal reference signal with a frequency of 10 MHz or 5 MHz is present at the socket REF FREQ 10 MHz.

In external reference mode, an external signal with a frequency of 10 MHz or 5 MHz must be fed into the socket REF FREQ 10 MHz.

The instrument is set to an input or output reference frequency of 10 MHz when delivered. The frequency of the reference signal at socket REF FREQ 10 MHz is determined by plug-in jumpers on module FRN LOOP (801.3917.02).

The plug-in jumper positions are:

Reference frequency	output	input
10 MHz	X13 BC	X11 BC
5 MHz	X13 AB	X11 AB

Note: With option SMG-B1 fitted and the operating mode "internal reference" selected, jumper X11 must be inserted on BC.

Frequency at the input/output REF FREQ 10 MHz: 10 MHz, (5 MHz)

Internal reference mode: Signal output
(0.2 V into 50 Ω , V_{rms}),
socket REF FREQ 10 MHz on rear
panel.

External reference mode: Signal input
(0.1 to 2 V (V_{rms}), sinewave,
squarewave or TTL), socket REF FREQ
10 MHz on rear panel.

The internal or external reference is selected using the keyboard or via the IEC bus.

Examples		a) Setting for external reference	b) Setting for internal reference
		PARAMETER	ON/OFF
a)		RF <input type="checkbox"/>	EXT AC <input type="checkbox"/>
b)		RF <input type="checkbox"/>	INT/ON <input type="checkbox"/>
IEC-bus codes	a)	REF:EXT	
	b)	REF:INT	

Display:

The text "REF EXT" appears in the frequency display if the external reference mode has been selected.

Note:

The externally applied reference frequency 10 MHz (5 MHz) must not deviate by more than $\pm 5 \times 10^{-6}$ from 10 MHz (5 MHz).

2.3.3 Frequency (RF)

Range: 100 kHz to 1000 MHz (settable from 10 kHz to 1040 MHz)

Resolution: 1 Hz

Units: GHz, MHz, kHz, Hz

Setting: RF ___ Data ___ Unit

Example		Setting of RF to 500 MHz			
	PARAMETER	DATA		ENTER/UNITS	
	RF				MHz
	<input type="text"/>	<input type="text" value="5"/>	<input type="text" value="0"/>	<input type="text" value="0"/>	<input type="text"/>
IEC-bus code	RF 500MHZ				

Display: The RF output frequency appears in the frequency display.

Associated instructions: Frequency offset (RF)
Sweep (RF)
Internal/external reference frequency

2.3.4 Frequency Offset (RF OFFSET)

The magnitude and sign of the offset can be adjusted. The RF output frequency is lower than the displayed frequency by the negative offset or higher by the positive offset. The offset is also effective in sweep mode.

Setting: SHIFT — RF OFFSET — Data — Unit

(Data without sign for positive offset, with minus sign for negative offset)

Switching on the RF offset without changing the stored value:

SHIFT — RF OFFSET — INT/ON
or
SHIFT — RF OFFSET — Unit

Switching off the RF offset:

SHIFT — RF OFFSET — OFF
or
SHIFT — RF OFFSET — 0 (zero) — Unit

Examples	a) Setting an offset of -10 MHz b) Switching off the offset c) Switching on an offset to the stored value								
		PARAMETER		ON/OFF	—	DATA	—	ENTER/UNITS	
a)	SHIFT	<input type="checkbox"/>	RF OFFSET	<input type="checkbox"/>		<input type="text" value="-"/>	<input type="text" value="1"/>	<input type="text" value="0"/>	MHz <input type="text"/>
b)	SHIFT	<input type="checkbox"/>	RF OFFSET	OFF	<input type="checkbox"/>				
c)	SHIFT	<input type="checkbox"/>	RF OFFSET	INT/ON	<input type="checkbox"/>				
IEC-bus codes	a)	RF:OFFS -10MHZ							
	b)	RF:OFFS:OFF							
	c)	RF:OFFS:ON							

Display: The text "OFFSET" appears in the frequency display if an offset is set.

The offset value is output in the frequency display by pressing the key sequence SHIFT RF — OFFSET, as long as the key RF offset is pressed.

Associated Frequency (RF)
instructions: Sweep (RF)

2.3.5 Level

Range: -140.1 to 13 dBm (0.022 μ V to 1 V), adjustable up to 16 dBm

Resolution: 0.1 dB

Units: dBm, dB μ V, mV, μ V

Setting: LEVEL — Data — Unit

Examples		a) Setting a level of 60 dB μ V b) Switching off the level c) Switching on the level to the stored value			
	PARAMETER	ON/OFF	— DATA —	ENTER/UNITS	
a)	LEVEL <input type="checkbox"/>		<input type="text" value="6"/> <input type="text" value="0"/>	<input type="text"/> dB μ V	
b)	LEVEL <input type="checkbox"/>	OFF <input type="text"/>			
c)	LEVEL <input type="checkbox"/>	INT/ON <input type="text"/>			
IEC-bus codes	a)	LEV 60DBUV			
	b)	LEV:OFF			
	c)	LEV:ON			

Associated instructions: Level offset
Non-interrupting level setting
Level EMF
Level control without function

2.3.6 Level Offset

The magnitude and sign of the level offset can be adjusted. The offset can only be entered in dB. The RF output level is lower than the displayed level by the negative offset or higher by the positive offset. The offset is also effective with a non-interrupting level setting.

Setting: SHIFT — LEVEL OFFSET — Data — dB

(Data without sign for positive offset, with minus sign for negative offset)

Switching on the offset without changing the stored value:

SHIFT — LEVEL OFFSET — INT/ON
or
SHIFT — LEVEL OFFSET — dB

Switching off the offset:

SHIFT — LEVEL OFFSET — OFF
or
SHIFT — LEVEL OFFSET — 0 (zero) — dB

Examples		PARAMETER	ON/OFF	DATA	ENTER/UNITS
a)	Setting an offset of 1.5 dB	SHIFT	LEVEL OFFSET	1 . 5	dB
b)	Switching off the offset	SHIFT	LEVEL OFFSET OFF		
c)	Switching on the offset to the stored value	SHIFT	LEVEL OFFSET INT/ON		
IEC-bus codes	a)	LEV:OFFS 1.5DB			
	b)	LEV:OFFS:OFF			
	c)	LEV:OFFS:ON			

Display: The text "OFFSET" appears in the amplitude display if an offset is set.

The (stored) offset value is output in the amplitude display using the key sequence SHIFT — LEVEL OFFSET, as long as the key LEVEL OFFSET is pressed.

Associated instructions: Level
Non-interrupting level setting
Level EMF
Level control without function

2.3.7 Non-interrupting Level Setting

In this special function, an electronic attenuation setting is used over a dynamic range of 20 dB instead of the level-interrupting mechanical attenuator.

The 20-dB non-interrupting range extends from the level set when the special function is switched on to 20 dB below. Using the special function "Fine variation starting from -20 dB", the special function "Non-interrupting level setting" is modified such as to increase a fixed level by 20 dB. Within this 20-dB range, non-interrupting level setting is possible via the keyboard, the rotary knob or the IEC bus.

Setting of a level outside the 20-dB range is made using the mechanical attenuator set. Starting from this new level, non-interrupting level setting is again used to decrease the level in the range 0 to -20 dB or increase the level in the range -20 dB to 0 dB with the special function "Fine variation starting from -20 dB" selected.

If the special function is switched on again when already switched on, this has the same effect as if the special function were switched on for the first time, i.e. the full 20-dB range is then available referred to the set level.

Special function "Non-interrupting level setting":
switch-on code: 1
switch-off code: 2

Special function "Fine variation starting from -20 dB":
switch-on code: 43
switch-off code: 44

Note: Specifications concerning level error, modulation depth error and distortion factor with AM do not apply with the special function "Non-interrupting level setting" switched on. When switching on the special function "Non-interrupting level setting", the special function "Pulse modulation with level control voltage from table" is switched off.

Associated instructions: Level
Level offset
Level EMF
Level control without function
Special functions

2.3.8 Level Control Without Function

With the special function "Level control without function", internal level control is switched over to a sample-and-hold mode. This special function is used for multi-transmitter measurements to achieve a higher signal-to-intermodulation ratio. The self-intermodulation products of two generators connected using a resistive 6-dB combiner remain below -60 dBc for output levels of 13 dBm, and below -80 dBc for output levels of less than 3 dBm.

In this special function, the SMG can be operated as usual. With high levels, the VSWR of the input impedance deteriorates.

Switching on of special function with code 23 } See special
Switching off of special function with code 24 } functions

Note: The specifications in the data sheet concerning level error and VSWR do not apply in the special function "Level control without function". AM is not possible with the special function switched on. The attempt to switch on e.g. AM INT is rejected during keyboard entry, the IEC-bus command AM:INT causes special function 23 to be switched off and AM INT on.

The minimum step time is 150 ms for the RF sweep with special function 23 switched on.

If the special function is switched on, "Pulse modulation (code 19)" is not possible. By activating the special function, the function "Pulse modulation (code 19)" is switched off.

Associated instructions: Level
Level offset
Level EMF
Special functions

2.3.9 Level EMF

With the special function "Level EMF", the EMF value of the RF voltage is displayed and no longer the value of the RF voltage into 50 Ω . The EMF display appears if one of the units dB μ V, mV or μ V is selected.

Switching on of special function with code 03 } See special
Switching off of special function with code 04 } functions

Associated instructions: Level
Level offset
Non-interrupting level setting
Level control without function
Special functions

2.3.10 Internal AF Modulation Frequency

8 fixed frequencies: 40 Hz, 150 Hz, 300 Hz, 400 Hz,
1 kHz, 3 kHz, 6 kHz, 15 kHz

Frequency range with the option AF Synthesizer SMG-B2:

10 Hz to 100 kHz (settable from 1 Hz with restricted data)

Resolution: 1 Hz (4-digit display, floating point)

The internal AF oscillator is automatically switched on as the modulation source in the case of internal modulation. The internal AF oscillator can also be switched on for external use of the AF signal if no internal modulation is on.

The AF signal is present at the output AF INT 8 in both cases. The amplitude is constant at 1 V (V_{rms}) with the standard fixed frequency oscillator. The amplitude can be adjusted between 1 mV and 1 V using the option AF Synthesizer SMG-B2 (see section "AF Amplitude").

Setting the frequency: AF — Data — Unit

The frequency can be set for the AF synthesizer and the fixed frequency oscillator using the rotary knob or the STEP $\uparrow\downarrow$ keys. Entry of the step size is omitted for the fixed frequency oscillator.

Examples		a) Setting of AF (int. mod. frequency) to 400 Hz b) Switching on the AF signal to the stored value c) Switching off the AF signal			
	PARAMETER	ON/OFF	DATA		ENTER/UNITS
a)	AF <input type="text"/>		<input type="text" value="4"/>	<input type="text" value="0"/>	<input type="text" value="0"/> Hz
b)	AF <input type="text"/>	INT/ON <input type="text"/>			
c)	AF <input type="text"/>	OFF <input type="text"/>	(no effect as long as internal modulation is switched on)		
IEC-bus codes	a)	AF 400HZ			
	b)	AF:ON			
	c)	AF:OFF			

Display: The AF is output in the right-hand half of the modulation display if the internal AF oscillator is switched on or if the AF parameter is set.

Associated instructions: AF amplitude
Modulation (AM, FM, ϕ M)
Modulation, two-tone

2.3.11 AF Amplitude

The amplitude of the AF signal present at the output AF INT 8 can be adjusted using this special function.

V_{rms} (AF): 1 mV to 1 V (can be set to 1.023 V)
Resolution: 1 mV

This is only possible if the instrument is fitted with option AF Synthesizer SMG-B2.

Switching on of special function with code 05 } see special
Switching off of special function with code 06 } functions

Switching on the special function does not switch on the AF oscillator. As described in the section "Internal AF Modulation Frequency", the AF signal can be switched on using AF — INT/ON and switched off using AF — OFF.

If the special function is switched on, both parameters LEVEL (RF) and LEVEL (AF) can be set using the level key in the parameter keypad. The last key pressed (RF or AF) determines the meaning of the LEVEL key.

Setting the parameter LEVEL (RF):



The entered values and variations then apply to the RF level until the AF key is pressed.

Setting the parameter LEVEL (AF):



The entered values and variations then apply to the AF level until the RF key is pressed.

The AF amplitude must be entered in mV (V_{rms}).

Examples		a) Setting of AF voltage to 150 mV			
		b) Switching off the AF signal			
		PARAMETER	ON/OFF	DATA	ENTER/UNITS
		LEVEL			
a)	AF	<input type="text"/>		<input type="text" value="1"/> <input type="text" value="5"/> <input type="text" value="0"/>	<input type="text"/> mV
b)	AF	<input type="text"/>	OFF	<input type="text"/>	
IEC-bus codes	a)	LEV:AF 150MV			
	b)	AF:OFF			

Display: The voltage of the AF output signal is output in the amplitude display after setting the parameter LEVEL (AF).

The level of the RF output signal is output in the amplitude display after setting the parameter LEVEL (RF).

Associated instructions: Level
Level offset
Non-interrupting level setting
Sweep (AF)
Special functions

2.3.12 Modulation, AM

Modulation depth: 0 to 99% (can be set to 100%)

Resolution: 0.5%

External modulation frequency range: 10 Hz to 50 kHz (EXT AC)
DC to 50 kHz (EXT DC)

Internal modulation frequencies: 40 Hz, 150 Hz, 300 Hz, 400 Hz,
1 kHz, 3 kHz, 6 kHz, 15 kHz

With option AF Synthesizer SMG-B2: 10 Hz to 50 kHz
(can be set to 1kHz to 100kHz)

The internal modulation source and one external modulation source can be switched on simultaneously (see "Two-tone modulation").

With increasing level in the range from 7 dBm to 13 dBm, the specified AM data are only guaranteed for a linearly decreasing modulation depth. Setting a too large modulation depth leads to the status display "71" (AM not specified with set level).

Setting: AM ___ Data ___ %

Selection of modulation source: AM ___ INT/ON or
AM ___ EXT AC (EXT DC)

Selection of internal modulation frequency: See section "Internal AF Modulation Frequency".

Switching off the AM: AM ___ OFF

Switching on the AM to the stored value (new value not entered):

AM ___ INT/ON or
AM ___ EXT AC (EXT DC)

Note: If one of the special functions "Pulse modulation (code 19)", "Pulse modulation (code 29)", "Pulse modulation with level control voltage from table" or "Level control without function" is switched on, AM cannot be switched on (exception: When switching on AM via IEC bus, the special functions "Pulse modulation (code 19)" and "Level control without function" are switched off and AM is switched on).

The value of the entered modulation depth is rounded to 0.5 %.

Examples	a) Setting and switching on the AM with m = 80%			
	b) Selection of the external modulation source			
	c) Switching off the AM			
	PARAMETER	ON/OFF	— DATA —	ENTER/UNITS
a)	AM <input type="text"/>		<input type="text" value="8"/> <input type="text" value="0"/>	% <input type="text"/>
b)	AM <input type="text"/>	EXT DC <input type="text"/>		
c)	AM <input type="text"/>	OFF <input type="text"/>		
IEC-bus codes	a)	AM 80%		
	b)	AM:EXT:DC		
	c)	AM:OFF		

Display:

AM^{EXT}_{INT} DC %

If amplitude modulation is switched on, this is indicated by

AM^{EXT}, AM^{EXT} DC, AM_{INT}, AM^{EXT}_{INT}, AM^{EXT} DC_{INT}

depending on the modulation source selected.

The modulation depth is output with 3 digits in the modulation display. The display is common to the modulation depth with AM and the deviation with FM or φM. If AM and FM or AM and φM are present simultaneously, the value of the parameter AM, FM or φM is displayed which was pressed last in the parameter keypad.

Associated Instructions:

Level
 Internal AF modulation frequency
 Modulation, external source
 Modulation, two-tone
 Special functions

2.3.13 Modulation, FM

Deviation:	0 to 800 kHz (depending on the carrier frequency)
Resolution:	10 Hz, 100 Hz, 1 kHz
External modulation frequency range:	10 Hz (3 Hz) to 100 kHz (EXT AC) DC to 100 kHz (EXT DC)
Internal modulation frequencies:	40 Hz, 150 Hz, 300 Hz, 400 Hz, 1 kHz, 3 kHz, 6 kHz, 15 kHz
With option AF Synthesizer SMG-B2:	10 Hz to 100 kHz

The internal modulation source and one external modulation source can be switched on simultaneously (see section "Modulation, Two-tone").

The RF output signal is no longer phase-synchronized with FM EXT DC.

The special function "Low rate FM" permits to extend the modulation frequency range in the case of EXT AC to 3 Hz to 100 kHz.

Switching on the special function with code 33 } see
Switching off the special function with code 34 } special functions

Setting:	FM ___ Data ___ Unit
Selection of the modulation source:	FM ___ INT/ON or FM ___ EXT AC or FM ___ EXT DC
Selection of the internal modulation frequency:	See section "Internal AF Modulation Frequency".
Switching off the FM:	FM ___ OFF
Switching on the FM to the stored value (new value not entered):	FM ___ INT/ON or FM ___ EXT AC or FM ___ EXT DC

Examples	a) Setting and switching on the FM with 40 kHz deviation			
	b) Selection of modulation source EXT AC			
	c) Switching off the FM			
	PARAMETER	ON/OFF	— DATA —	ENTER/UNITS
a)	FM <input type="text"/>		<input type="text" value="4"/> <input type="text" value="0"/>	kHz <input type="text"/>
b)	FM <input type="text"/>	EXT AC <input type="text"/>		
c)	FM <input type="text"/>	OFF <input type="text"/>		
IEC-bus codes	a)	FM 40KHZ		
	b)	FM:EXT:AC		
	c)	FM:OFF		

Display:

FM ^{EXT} ^{DC} kHz
 _{INT}

If frequency modulation is switched on, this is indicated by

FM^{EXT}, FM^{EXT} DC, FM_{INT}, FM_{INT}^{EXT} or

FM_{INT}^{EXT} DC

depending on the modulation source selected.

The deviation is output with 3 digits in the modulation display. The display is common to the deviation with FM or φM and the modulation depth with AM. If AM and FM or AM and φM are present simultaneously, the value of the parameter AM, FM or φM is displayed which was pressed last in the parameter keypad.

Associated instructions: Internal AF modulation frequency
 Modulation, external source
 Modulation, two-tone
 Special functions

2.3.14 Modulation, ϕM

Deviation: 0 to 80 rad (depending on the carrier frequency)

Resolution: 0.001, 0.01, 0.1 rad

External modulation frequency range: 10 Hz to 10 kHz

Internal modulation frequencies: 40, 150, 300, 400 Hz, 1, 3, 6 kHz

With option AF Synthesizer SMG-B2: 10 Hz to 10 kHz

The internal modulation source and one external modulation source can be switched on simultaneously (see section "Modulation, Two-tone").

Setting: ϕM — Data — Rad

Selection of modulation source: ϕM — INT/ON or ϕM — EXT AC

Selection of internal modulation frequency: See section "Internal AF Modulation Frequency"

Switching off the ϕM : ϕM — OFF

Switching on the ϕM to the stored value (new value not entered): ϕM — INT/ON or ϕM — EXT AC

Examples	a) Setting and switching on the ϕM with 20 rad deviation			
	b) Selection of modulation source INT			
	c) Switching off the ϕM			
	PARAMETER	ON/OFF	— DATA —	ENTER/UNITS
a)	ϕM <input type="text"/>		<input type="text" value="2"/> <input type="text" value="0"/>	Rad. <input type="text"/>
b)	ϕM <input type="text"/>	INT/ON <input type="text"/>		
c)	ϕM <input type="text"/>	OFF <input type="text"/>		
IEC-bus codes	a)	PHM 20RAD		
	b)	PHM:INT		
	c)	PHM:OFF		

Display:

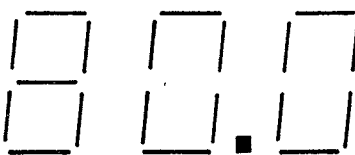
$\psi M_{\text{EXT}}^{\text{INT}}$  rad

If ϕM is switched on, this is indicated by

ϕM_{EXT} , ϕM_{INT} or $\phi M_{\text{INT}}^{\text{EXT}}$

depending on the modulation source selected.

The phase deviation is output with 3 digits in the modulation display. The display is common to the deviation with FM or ϕM and the modulation depth with AM. If FM and AM or ϕM and AM are present simultaneously, the value of the parameter AM, FM or ϕM is displayed which was pressed last in the parameter keypad.

Associated instructions: Internal AF modulation frequency
Modulation, external source
Modulation, two-tone

2.3.15 Modulation, FSK

Basically, frequency modulation with digital modulation signals is possible with AC or DC coupling in the operating mode FM-EXT. The required levels of the modulation signals are described in section "Modulation, External Source".

In the FSK mode, TTL signals can be fed into the FM/ϕM modulation input in addition to digital frequency modulation, provided that the instrument is fitted with the SMG-B2 AF Synthesizer option. The FSK mode is selected by switching on the special function "FSK modulation".

The deviation setting and selection of the modulation source is exactly as described in section "Modulation, FM". With a LOW level, the output frequency is equal to the set RF minus the deviation, with a HIGH level, it is equal to the set RF plus the deviation.

Note: Switching on the special function "FSK modulation" automatically switches off the special function "FM two-tone".

Special function "FSK modulation": switch-on code: 17
switch-off code: 18

Examples		a) Switching on the special function FSK			
		b) Switching off the special function FSK			
		PARAMETER	— DATA —		ENTER/UNITS
a)	SHIFT	<input type="checkbox"/> SPECIAL	<input type="text" value="1"/>	<input type="text" value="7"/>	<input type="text"/>
b)	SHIFT	<input type="checkbox"/> SPECIAL	<input type="text" value="1"/>	<input type="text" value="8"/>	<input type="text"/>
IEC-bus codes	a)	FM:FSK: AC			
	b)	FM:OFF			

Display: The mode display with FSK modulation is
FMEXT DC or FMEXT.

The set deviation is displayed next to this.

Associated instructions: Modulation, FM
Modulation, external source
Special functions

2.3.16 Pulse Modulation, PM

Pulse modulation is only possible with an external modulation source (TTL level).

Pulse modulation (code 19) is only possible when the device is equipped with the option SMG-B2 AF synthesizer.

It is not possible to set the AM mode when Pulse modulation is selected.

If AM had been previously selected, it will now be turned off.

Caution: In the case of pulse modulation using code 29 the pulse modulation is switched off and over to CW mode for approx. 150 ms by means of internal level calibration when frequency or level are changed. During calibration the RF level set ist present at the output.

If the calibration process is disturbing, pulse modulation using code 31 should be chosen. Instead of a calibration with each changing of frequency or level, correction values of a stored table are used. A lower level accuracy has to be expected.

2.3.16.1 Pulse Modulation (Code 29)

The operating mode "pulse modulation (code 29)" is selected by switching on special function 29. When selecting this operating mode and when changing the RF frequency or RF level, the level control is switched to the sample-and-hold mode.

ON/OFF ratio:	70 dB
Rise/fall time (10% to 90%)	
RF >200 MHz	20 ns
RF <200 MHz	60 ns
Modulation signal:	TTL
	High (>2V) for level on
	Low (<0.8 V) for level off
Modulation input:	PM EXT (rear panel)

Note: When switching on special function 29, the special functions "Pulse modulation (code 19)" and "Pulse modulation with level control voltage from table" are switched off.

The minimum step time for the RF sweep with pulse modulation (code 29) is 150 ms.

2.3.16.2 Pulse Modulation with Level Control Voltage from Table

This operating mode is selected by switching on special function 31. Instead of performing a level calibration each time the RF frequency or RF level is changed, correction values from a stored table are used. This table is updated by selecting the special function "Calibration routine for level control voltage from table (code 68)".

ON/OFF ratio: 70 dB
 Rise/fall time (10% to 90%)
 RF >200 MHz 20 ns
 RF <200 MHz 60 ns

Modulation signal: TTL
 High (>2V) for level on
 Low (<0.8 V) for level off

Modulation input: PM EXT (rear panel)

Note: When switching on special function 31, the special functions "Pulse modulation (code 19)", "Pulse modulation (code 29)" and "non-interrupting level setting" are switched off.

Special function "Pulse modulation with level control voltage from table":
 Switch-on code 31
 Switch-off code 32

Examples	a) Switching on the pulse modulation with level control voltage from table				
	b) Switching off the pulse modulation with level control voltage from table				
		PARAMETER	— DATA —		ENTER/UNITS
a)	SHIFT []	[] SPECIAL	[3]	[1]	[]
b)	SHIFT []	[] SPECIAL	[3]	[2]	[]
IEC-bus codes	a)	PULSE:LOOKUP			
	b)	PULSE:OFF			

Display: "PULS" is indicated in the modulation display as the operating mode.

Associated instructions: Special functions

2.3.16.3 Pulse Modulation (Code 19)

In order to ensure compatibility with older instruments, the operating mode pulse modulation can also be selected using special function 19. When selecting this operating mode and when changing the RF frequency or the RF level, the level control is switched to the sample-and-hold mode.

ON/OFF ratio: 40 dB
 Modulation bandwidth: DC to 50 kHz
 Rise/fall time (10% to 90%): 2µs
 Modulation signal: TTL
 High (>2V) for level off
 Low (<0.8 V) for level on
 Modulation input: AM EXT

Note:

When switching on special function 19, the special functions "Pulse modulation (code 29)", "Pulse modulation with level control voltage from table" and "AM two-tone" are switched off. When "Level control without function" is switched on, it is not possible to activate "Pulse modulation (code 19)".

Special function "Pulse modulation (code 19)":

Switch-on code: 19

Switch-off code: 20

Examples		a) Switching on the pulse modulation (code 19)		b) Switching off the pulse modulation (code 20)	
		PARAMETER	— DATA —	ENTER/UNITS	
a)	SHIFT	<input type="checkbox"/> SPECIAL	<input type="text" value="1"/> <input type="text" value="9"/>	<input type="text"/>	
b)	SHIFT	<input type="checkbox"/> SPECIAL	<input type="text" value="2"/> <input type="text" value="0"/>	<input type="text"/>	
IEC-bus codes	a)	AM:Pulse			
	b)	AM:OFF			

Display: "PULS" and "AM" is indicated in the modulation display as the operating mode.

Associated instructions: Special functions.

2.3.17 Modulation, External Source

The modulation inputs AM EXT and FM/ ϕ M EXT are available for externally applied modulation.

The two modulation inputs can be AC or DC coupled for the modulation modes AM and FM. The coupling is selected using the keys EXT AC and EXT DC in the parameter keypad.

The input impedance of the two inputs is 100 k Ω when the instrument is delivered.

The input impedance can be changed to 600 Ω using internal plug-in jumpers.

The jumpers are on the AF generator module (801.7312.02) if the instrument is not fitted with the option AF Synthesizer SMG-B2.

The jumper positions are:

Input impedance	FM/ ϕ M	AM
100 k Ω	X11 BC	X13 BC
600 Ω	X11 AB	X13 AB

The jumpers are on the option AF Synthesizer SMG-B2 if this option is fitted.

The jumper positions are:

Input impedance	FM/ ϕ M	AM
100 k Ω	X10 AC	X11 AC
600 Ω	X10 AB	X11 AB

A signal of 1 V_{rms} ($V_p = 1.41$ V) must be applied to achieve the deviation and modulation depth accuracies guaranteed in the data sheet.

Deviations from the required input voltage are indicated in the modulation display by LOW or HIGH.

The display LOW appears for voltages $V_{rms} \leq 0.97$ V, the display HIGH for voltages $V_{rms} \geq 1.03$ V. An external voltmeter must be used if greater accuracy is required.

Comment on FM DC:

This mode enables VCO operation or an externally applied analog sweep.

Modulation frequency DC to 100 kHz
Deviation (depending on the carrier frequency). 0 to 800 kHz
Tuning voltage -1.41 V to +1.41 V

The tuning range is determined by the deviation input. A range from -1.41 V to +1.41 V corresponds to a frequency increment from $f_{RF}-\text{deviation}$ to $f_{RF}+\text{deviation}$.

The generator output signal is not phase-synchronized in FM DC mode.

Comment to AM DC:

This mode enables external level control.

Modulation frequency DC to 50 kHz
Modulation depth 0 to 100%
Input voltage -1.41 V to +1.41 V

The level variation range is determined by the modulation depth input. A range from -1.41 V to +1.41 V corresponds to a change in level from $\text{level}_{0V} \cdot (1-m)$ to $\text{level}_{0V} \cdot (1+m)$.

level_{0V} is the RF level in V entered numerically.

The maximum range, e.g. for maximum carrier blanking in the case of pulse modulation, is at $m = 100\%$.

Associated instructions: Modulation, AM
Modulation, FM
Modulation, two-tone
Modulation, FSK
Modulation, PM

2.3.18 Modulation, Two-tone

Two-tone modulation takes place with the signals from the internal modulation source and an external modulation source.

The corresponding special function AM two-tone, FM two-tone or ϕ M two-tone must be switched on in order to connect internal and external modulation signals simultaneously. Modulation is not switched on simply by switching on the special function via the front panel or via IEC bus using SPEC 11, for example. (The IEC-bus commands AM/FM/PHM:DUAL, however, have the same effect as SPEC 11/13/15 followed by AM/FM/PHM:ON). Entry of the modulation parameters and switching on and off of the modulation must take place exactly as described in the sections on modulation AM, FM, ϕ M. Separate deviation or modulation depth settings for the internal and external modulation are not possible. The required voltage of the external modulation signal is 1 V (V_{rms}).

The total deviation or the total modulation depth is equal to twice the numerical value entered. Ensure that the permissible maximum values for deviation and modulation depth, as listed on the data sheet, are not exceeded.

Note: The special function "AM two-tone" automatically switches off the special function "Pulse modulation (code 19)". The special function "FM two-tone" automatically switches off the special function "FSK modulation".

Switch on/off codes of the special functions:

Type of modulation	Switch on	Switch off
AM two-tone	11	12
FM two-tone	13	14
ϕ M two-tone	15	16

Examples		a) Switching on the special function "FM two-tone"				b) Switching off the special function "FM two-tone"			
		PARAMETER	— DATA —		ENTER/UNITS				
a)	SHIFT	<input type="checkbox"/> SPECIAL	<input type="text" value="1"/>	<input type="text" value="3"/>	<input type="text"/>				
b)	SHIFT	<input type="checkbox"/> SPECIAL	<input type="text" value="1"/>	<input type="text" value="4"/>	<input type="text"/>				
IEC-bus codes	a)	FM:DUAL:AC DC							
	b)	FM:OFF							

Associated instructions: Modulation, (AM, FM, ϕ M)
Modulation, external source
Special functions

2.3.19 Variation, Rotary Knob

The rotary knob can be used for fast sweeps through wide ranges and for small variations with a fine step size.

The parameters which can be varied using the rotary knob are RF, AF, LEVEL (RF), LEVEL (AF) and the modulation depth with AM and the deviation with FM or ϕ M.

The amplitude of the AF signal can be varied by switching on the special function "AF amplitude" (only with the option AF Synthesizer SMG-B2). The SHIFT parameters such as fSTART or LEVEL OFFSET cannot be varied.

In normal cases (except HOLD mode) the set parameter (whose LED is lit in the parameter keypad) is varied using the rotary knob. The variation is automatically transferred to the new parameter when selected; the step size last selected for this parameter is used again.

In HOLD mode the variability is fixed to the parameter set when pressing the HOLD key. This parameter remains variable even if a different parameter is set (see section "Variation, HOLD").

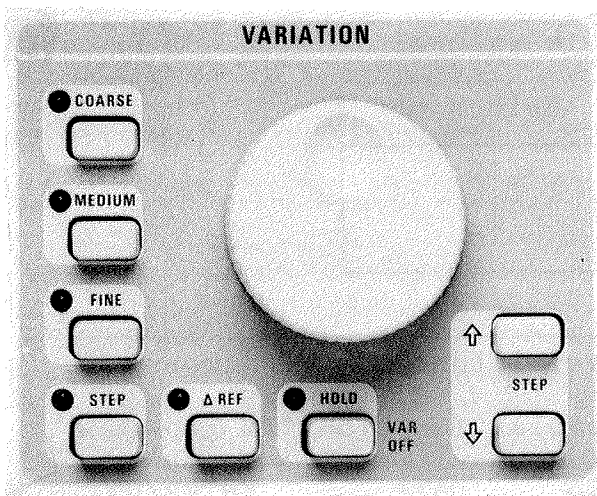

Fig. 2-10 VARIATION keypad

To cancel the knob function:

To set the knob function:

Operation:

Clockwise rotation increases the value of the set parameter, counter-clockwise rotation decreases it.

SHIFT — VAR OFF

Press one of the 4 step size keys COARSE, MEDIUM, FINE, STEP

Example	Cancel the knob function
	<p style="text-align: center;">VARIATION</p> <p>SHIFT VAR</p> <p><input type="checkbox"/> <input type="checkbox"/> OFF</p>

The rotary knob function cannot be programmed, instead the function VARIATION STEP can be programmed with the same effect (see section "Variation, Step").

Display: The rotary knob function is ready if one of the LEDs of the step size keys COARSE, MEDIUM, FINE or STEP is on.

Associated instructions: Rotary knob, step size
Variation, ΔREF
Variation, HOLD
Sweep (manual)

2.3.20 Rotary Knob, Step Size

The step size of the rotary knob variation can be set using the keys FINE, MEDIUM, COARSE (fixed step sizes) or with the key STEP (selectable step size).

The step size FINE results in a step size equal to the highest resolution for all parameters.

The ratio FINE to MEDIUM to COARSE is 1 : 10 : 100 except for RF where it is 1 : 10^3 : 10^6 . For example, levels with fixed step sizes 0.1 dB, 1 dB, 10 dB or with RF 1 Hz, 1 kHz, 1 MHz are therefore available.

The rotary knob step size becomes equal to the STEP size by pressing the STEP key in the variation keypad; the STEP size being freely selectable. A STEP size can be entered for each parameter and this value remains stored when the parameter is changed. (To enter the STEP size, see section "Variation, Step".)

As soon as a new parameter is set in the parameter keypad, the step size changes to the last value selected for this parameter (except in HOLD mode).

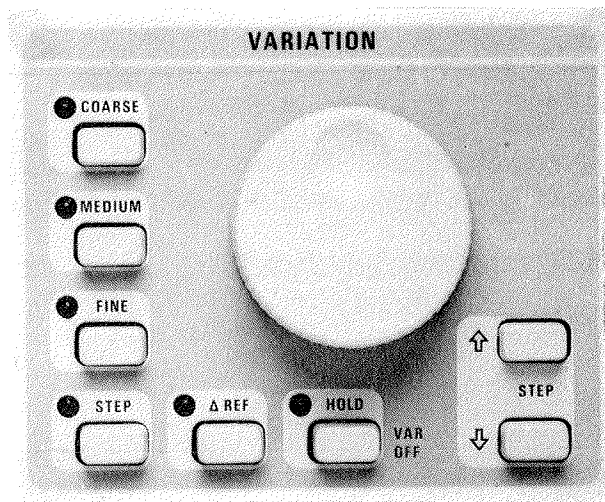

Fig. 2-11 VARIATION keypad

Selection of step size:

By pressing one of the 4 keys COARSE, MEDIUM, FINE or STEP

Display of step size:

By the LEDs of the step size keys

Associated instructions:

Variation, rotary knob
Variation, ΔREF
Variation, HOLD

2.3.21 Variation, HOLD

The HOLD function means that variability is not transferred to a new parameter. The parameter set when the HOLD key is pressed remains variable.

Switching on the HOLD function: Using the HOLD key in the variation keypad with the variation switched on

Switching off the HOLD function: SHIFT — VAR OFF

Display: By the LED of the HOLD key

Associated instructions: Variation, rotary knob
Rotary knob, step size
Variation, Δ REF

2.3.22 Variation, Δ REF

With function Δ REF the difference between the set value and the reference value is displayed for the variable parameter instead of the set value. The reference value is the value of the parameter when the Δ REF key is pressed:

Switching on the Δ REF function: Using the Δ REF key in the variation keypad with the variation switched on

Switching off the Δ REF function: By setting a new parameter (if the HOLD function is not switched on) or by the key sequence SHIFT — VAR OFF

Display: By the LED of the Δ REF key and the reference " Δ " in the display of the variable parameter

Associated instructions: Variation, rotary knob
Rotary knob, step size
Variation, HOLD

2.3.23 Variation, Step

The function VARIATION STEP enables parameters to be increased or decreased in selectable steps. The set parameter (whose LED in the parameter keypad is on) is variable.

Variable parameters are RF, AF, LEVEL (RF), LEVEL (AF) and the modulation depth with AM and the deviation with FM or ϕ M. The SHIFT parameters, e.g. f_{START} or LEVEL OFFSET cannot be varied.

A STEP size can be entered for each variable parameter which remains stored when the parameter is changed.

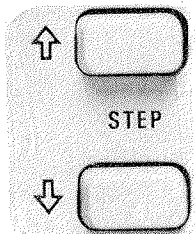

Stepping takes place by pressing the STEP $\uparrow\downarrow$ keys in the variation keypad or by rotating the knob with STEP selected.

By continuous pressing the STEP $\uparrow\downarrow$ keys the stepping takes place repeatedly, slowly at first and then faster.

The STEP $\uparrow\downarrow$ keys are always active as long as a parameter is set.

The variation of parameters in freely selectable steps via IEC bus is performed using the commands

INCREMENT: <parameter> and
DECREMENT: <parameter>.

The modulation depth with AM and the deviation with FM or PHM are only changed if modulation is switched on.

Entry of the STEP size:

Parameter — STEP — Data — Unit

The STEP key must be pressed again for each data input. The parameter key need not be first pressed if the parameter is already set (LED is on).

The smallest step sizes for the various parameters are:

Frequency (RF)	1 Hz
Frequency (AF)	1 Hz
Level (RF)	0.1 dB
Level (AF)	1 mV
Modulation depth (AM)	0.5%
Deviation (FM)	10 Hz
Deviation (ϕ M)	0.001 rad

The STEP size of the level may only be entered in dB, even if mV or μ V is selected as the level unit.

Example		Setting an RF step size of 25 kHz		
	PARAMETER	DATA		ENTER/UNITS
	RF STEP	<input type="text"/>	<input type="text"/>	kHz
		<input type="text" value="2"/>	<input type="text" value="5"/>	<input type="text"/>
IEC-bus code	RF:VAR_STEP 25KHZ			

Display: A new step size is output in the display of the set parameter until the entry is terminated by the unit key. The set value of the parameter is then displayed.

The step size entered for a parameter can be displayed by pressing the STEP key in the parameter keypad with the parameter set (parameter LED on).

Associated instructions: Variation, rotary knob

2.3.24 Sweep (RF)

With a sweep the change in frequency takes place in selectable steps and not continuously.

A sweep is possible across the complete frequency range from 100 kHz to 2000 MHz in minimum steps of 1 Hz.

A linear or logarithmic sweep (see "Sweep (RF), Logarithmic") can be selected.

The following sweep modes are available:

Automatic (AUTO) Sweep from the start frequency to the stop frequency with an automatic restart at the start frequency.

Single (SINGLE) Single sweep from the start frequency to the stop frequency.

Manual (MAN) Rotary knob variation within the sweep limits at the selected step size f_{STEP} .

Reset (RESET) Return frequency to start frequency f_{START} .

2.3.25 Sweep (RF), Parameter Entry

The adjustable parameters are:

f_{START} , f_{STOP} Start frequency, stop frequency
 f_{STEP} Step size ($\Delta f/STEP$)
TIME/STEP Time per step ($\Delta t/STEP$)

Table 2-1 Ranges of adjustment of the sweep parameters

Sweep parameter	Range of adjustment	Resolution
f_{START} , f_{STOP}	100 kHz to 1000 MHz ¹⁾	1 Hz
f_{STEP}	1 Hz to 999.9 MHz ²⁾	1 Hz
TIME/STEP	10 ms to 10 s ³⁾	1 ms

¹⁾ 10 kHz to 1040 MHz can be set

²⁾ 1 Hz to 1039.999 Mz can be set

³⁾ The minimum step time is 150 ms if one of the special functions "Pulse modulation (code 29)" or "Level control without function" (code 23) is switched on. The stored value for TIME/STEP is maintained.

The sweep parameters f_{START} , f_{STOP} , f_{STEP} , TIME/STEP are SHIFT parameters. They are set by first pressing the SHIFT key and then the parameter key. The SHIFT parameters remain set as the sweep parameters only for one numerical entry. They must therefore be set again with each new entry. The sweep parameters cannot be varied using the rotary knob or the STEP $\uparrow\downarrow$ keys.

The sweep parameters can also be entered whilst a sweep is in progress.

Input sequence: SHIFT — Sweep parameter — Data — Unit

Examples		a) Entry of start frequency 100 MHz		b) Entry of step size 50 ms	
	PARAMETER	DATA			ENTER/UNITS
a)	SHIFT [] f _{START} []	[1]	[0]	[0]	MHz []
b)	SHIFT [] TIME/ STEP []	[5]	[0]		ms []
IEC-bus codes	a)	RF:START 100MHZ			
	b)	TIME:RF_SWP 50MS			

Display: If the SHIFT key has already been pressed, the parameter is output in the frequency display as long as the parameter key is pressed.

The digits of a new value are displayed progressively when entered (DATA keys).

2.3.26 Sweep (RF), Operating Modes

The sweep is switched on or off and the sweep mode is selected using the keys in the SWEEP keypad.

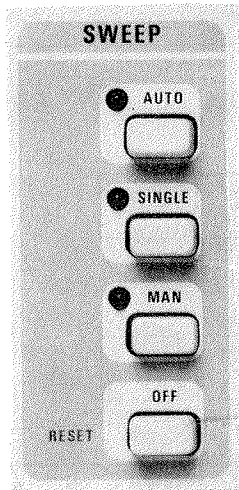

Fig. 2-12 SWEEP keypad

AUTO

- 1) Pressing the AUTO key when the LED is off:
 - starts a sweep from the set frequency to the stop frequency with an automatic restart at the start frequency if the set frequency is within the sweep range.
 - starts a sweep from the start frequency to the stop frequency with an automatic restart at the start frequency if the set frequency is outside the sweep range or equal to f_{STOP} .
- 2) Pressing the AUTO key when the LED is on:
 - starts a new sweep from the start frequency to the stop frequency with an automatic restart at the start frequency.

SINGLE

- 1) Pressing the SINGLE key when the LED is off:
 - starts a single sweep from the set frequency to the stop frequency if the set frequency is within the sweep range.
 - starts a single sweep from the start frequency to the stop frequency if the set frequency is outside the sweep range or equal to f_{STOP} .
- 2) Pressing the SINGLE key when the LED is on:
 - starts a single sweep from the start frequency to the stop frequency.

MAN

Manual sweep within the limits f_{START} , f_{STOP} using the rotary knob.

Pressing the MAN key

- does not change the set frequency if it is within the sweep range.
- sets the frequency to f_{START} if the set frequency is outside the sweep range.
- interrupts a sweep at the frequency reached.

RESET

Pressing the SHIFT and RESET keys

- sets the frequency to f_{START} .

OFF

Pressing the OFF key

- switches the sweep off at the frequency reached.

The sweep is also switched off at the frequency reached by pressing the RF key in the parameter keypad.

2.3.28 Sweep (RF), Logarithmic

With the logarithmic sweep the step size f_{STEP} ($\Delta f/STEP$) is equal to a constant fraction of the current frequency.

The sweep is logarithmic if the special function "Logarithmic sweep" is switched on. This special function is switched on with code 07 and off with code 08.

The sweep parameters f_{START} , f_{STOP} , $TIME/STEP$ are identical for linear and logarithmic sweeps and are only stored once. The sweep parameter f_{STEP} is stored twice, however, once in % for the logarithmic sweep and once in Hz for the linear sweep.

Switching on and off of the sweep modes, the display of the sweep and the entry of the sweep parameters (except f_{STEP}) remain the same (see "Sweep (RF), Parameter Entry", "Sweep (RF), Operating Modes", "Sweep (RF), Display").

f_{STEP} is entered in % referred to the respective frequency. The entry of f_{STEP} in % is only possible if the special function "Logarithmic sweep" is switched on.

Range of adjustment of f_{STEP} : 0.01% to 50%

Resolution of f_{STEP} : 0.01%

Examples		a) Switching on the special func. "Log. sweep"			
		b) Switching off the special func. "Loq. sweep"			
		c) Setting a step size of 10%			
		PARAMETER	— DATA —		ENTER/UNITS
a)	SHIFT	<input type="checkbox"/> SPECIAL	<input type="text" value="0"/>	<input type="text" value="7"/>	<input type="text"/>
b)	SHIFT	<input type="checkbox"/> SPECIAL	<input type="text" value="0"/>	<input type="text" value="8"/>	<input type="text"/>
c)	SHIFT	f_{STEP} <input type="checkbox"/>	<input type="text" value="1"/>	<input type="text" value="0"/>	% <input type="text"/>
IEC-bus codes	a)	SWP:MODE:RF:LOG			
	b)	SWP:MODE:RF:LIN			
	c)	RF:LOG_STEP 10%			

Associated instructions: Sweep (RF); Sweep (RF), parameter entry
Sweep (RF), operating modes; sweep (RF), display
Sweep (AF); special functions

2.3.29 Sweep (AF)

AF sweep is possible if the instrument is fitted with the option AF Synthesizer SMG-B2.

RF and AF sweeps cannot function simultaneously.

The special function "Sweep AF" enables the instrument to carry out an AF sweep. The special function is switched on using code 09 and off using code 10.

The sweep is switched on or off and the sweep mode is selected using the keys in the SWEEP keypad.

The amplitude of the AF signal at output AF INT (usually 1 V_{rms}) can be set using the special function "AF Amplitude".

The AF sweep can also be used to sweep the modulation frequency with internal modulation. The internal modulation and the AF sweep must then be switched on simultaneously. The modulation frequency ranges for AM, FM and ϕ M must not be exceeded.

Associated AF amplitude
instructions: Special functions

2.3.30 Sweep (AF), Parameter Entry

The sweep parameter inputs (f_{START} , f_{STOP} , f_{STEP} , TIME/STEP) apply to the AF sweep if the special function "Sweep AF" is switched on (see section "Sweep (RF), Parameter Entry").

The sweep parameters are stored separately for the AF sweep and the RF sweep.

Table 2-3 Ranges of adjustment of the AF sweep parameters

Sweep parameter	Range of adjustment	Resolution
f_{START} , f_{STOP}	10 Hz to 100 kHz	1 Hz up to 10 kHz 10 Hz above 10 kHz
f_{STEP}	1 Hz to 99.9 kHz	1 Hz
TIME/STEP	10 ms to 10 s	1 ms

Examples		a) Switching on the special function "Sweep AF"		b) Switching off the special function "Sweep AF"		c) Setting a start frequency of 10 kHz	
		PARAMETER	— DATA —		ENTER/UNITS		
a)	SHIFT <input type="text"/>	<input type="text"/> SPECIAL	<input type="text" value="9"/>		<input type="text"/>		
b)	SHIFT <input type="text"/>	<input type="text"/> SPECIAL	<input type="text" value="1"/>	<input type="text" value="0"/>	<input type="text"/>		
c)	SHIFT <input type="text"/>	f _{START} <input type="text"/>	<input type="text" value="1"/>	<input type="text" value="0"/>	kHz <input type="text"/>		
IEC-bus codes	a)	SWP:MODE:AF:	LIN LOG				
	b)	SWP:MODE:RF:	LIN LOG				
	c)	AF:START	10KHZ				

Display: After pressing the SHIFT key, the parameter is output in the right-hand section of the modulation display as long as the parameter key is pressed.

The digits of the new value are displayed progressively during the numerical input (DATA keys).

2.3.31 Sweep (AF), Operating Modes

If the special function "Sweep AF" is switched on, the key operations in the SWEEP keypad automatically apply to the AF sweep.

The functions of the keys in the SWEEP keypad are the same as with RF sweep (see section "Sweep (RF), Operating Modes").

Notes: By pressing the AF key in the parameter keypad, the AF sweep is switched off at the current frequency.

With the AF sweep switched on, the RF can be changed by a numerical entry or by a rotary knob or step variation.

2.3.31 Sweep (AF), Display

The AF sweep mode is indicated just like the RF sweep by one of the LEDs in the SWEEP keypad (see section "Sweep (RF), Display"). Depending on the operating mode and status, the frequency is displayed successively or fixed in the right-hand section of the modulation display.

2.3.32 Sweep (AF), Logarithmic

The AF sweep is logarithmic if the special function "Logarithmic Sweep" is switched on. See section "Sweep (RF), Logarithmic" for operating the logarithmic sweep.

2.3.33 Sweep (RF, AF) X Output and Z Output

The option SMG-B3 supplies the signals required for controlling and triggering oscilloscopes or XY recorders at the outputs X-Axis and Z-Axis. These signals are available both with RF and AF sweep.

Auto sweep

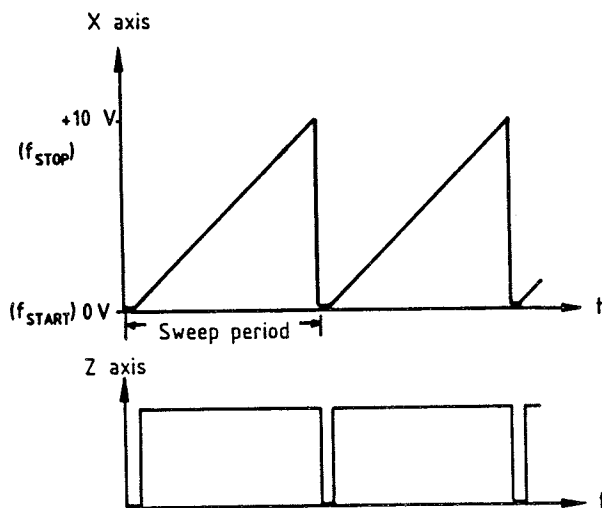

Single sweep

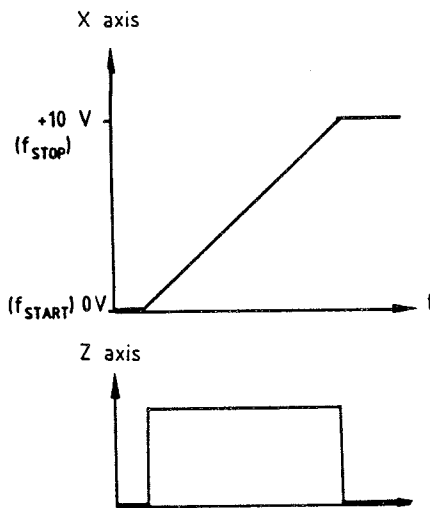

Z-axis signal with inverted polarity (special function):

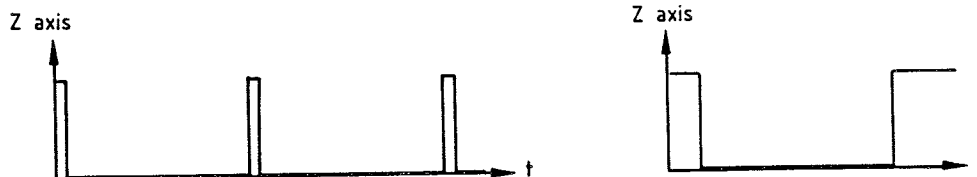

The special function Z axis inverted is switched on using code 27 and switched off using code 28.

Associated instructions: Special functions

Auto sweep

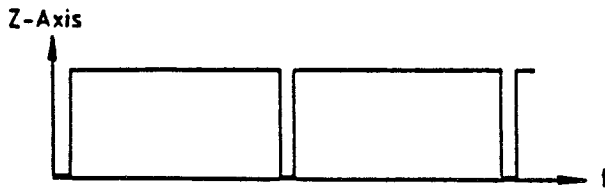

Single sweep

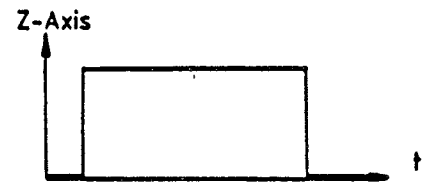

using special function "Z-axis inverted":

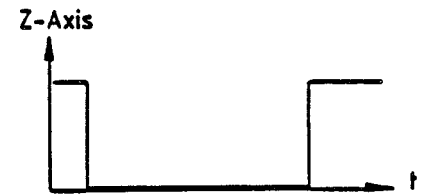
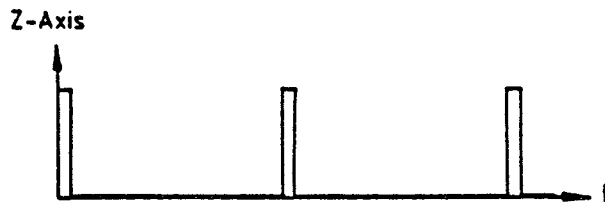

The special function "Z axis inverted" is switched on using code 27 and switched off using code 28.

Associated instructions: Special functions

2.3.35 Store - Recall

50 complete instrument settings can be stored.

If an instrument setting is called with the sweep mode SINGLE or AUTO, the sweep is started at f_{START}.

Storing the current instrument setting:

STO — Memory address — ENTER/UNITS

Recall an instrument setting:

RCL — Memory address — ENTER/UNITS

Any one of the four ENTER/UNITS keys can be pressed following the data entry to activate store or recall.

Examples	a) Storing an instrument setting at memory location 7			
	b) Storing an instrument setting at memory location 25			
	c) Recalling the instrument setting from memory location 7			
		MEMORY	— DATA —	ENTER/UNITS
a)	STO <input type="text"/>		<input type="text" value="7"/>	<input type="text"/>
b)	STO <input type="text"/>		<input type="text" value="2"/> <input type="text" value="5"/>	<input type="text"/>
c)	RCL <input type="text"/>		<input type="text" value="7"/>	<input type="text"/>
IEC-bus codes	a) STO 7			
	b) STO 25			
	c) REC 7			

Location 0 serves for a special function, i.e. the current instrument setting prior to the last memory recall is stored at this location. This instrument setting can be set again using RCL 0.

By selecting the special function "Clear memory (code 50)", the memories 0 to 50 are overwritten by default values and thus cleared. This function is therefore also the reset function of the special function "Display off".

Using the functions SEQ (sequence) and AUTO SEQ, the memory settings can be read out in a previously defined order by repeated keying or automatically.

Associated instructions: Sequence
Special functions

2.3.36 Sequence

The sequence function can be used to recall stored settings in a previously defined order by repeated keying (SEQ). When the last memory location of the sequence has been called, the first one is automatically called again.

The "Automatic sequence" function enables a single automatic sequence of stored settings in a previously defined order.

The duration of each setting in the automatic sequence can be determined by a numerical input.

Special function "AUTO SEQ repeat":

The automatic sequence does not just run once but is repeated if the special function "AUTO SEQ repeat" is switched on.

The special function "AUTO SEQ repeat" is switched on using code 21 and off using code 22.

Caution: The mechanical attenuator, if activated, is highly loaded by "AUTO SEQ repeat" with short step times and a long operating time.

Operation: Start an automatic sequence using keys

SHIFT — AUTO SEQ

SHIFT



AUTO SEQ

Stop an automatic sequence using the key SEQ or the keys SHIFT — INSTR PRESET.

Entry of a sequence:

- a) Any sequence
A sequence can be defined in any order for memory locations 1 to 9. Memory locations can also be repeatedly used (e.g. 4. 6. 3. 6. 9.). A sequence can contain up to 10 memory locations.
- b) Fixed sequence
A fixed sequence is permissible for memory locations 1 to 50.

Entry of the step time (Δt /sequence step):

SHIFT — TIME/STEP — Data — ENTER/UNITS

Range of adjustment: 30 ms to 60 s

Resolution: 1 ms

Examples		a) Input of any sequence 4 6 3 6 9	b) Input of the constant sequence 5 to 35	c) Input of the step time 100 ms
		MEMORY ————— DATA ————— ENTER/UNITS		
a)	SHIFT [] [] SET SEQ	[4] [.] [6] [.] [3]	[.] [6] [.] [9] [.]	[]
b)	SHIFT [] [] SET SEQ	[5] [-] [3] [5]	[]	
c)	SHIFT [] [] TIME/STEP	[1] [0] [0]	ms []	

Display: The set sequence is output in the FREQUENCY display as long as the SET SEQ key is pressed after pressing the SHIFT key.

Display of any sequence 4 6 3 6 9 7:

4.6.3.6.9.7.

Display of the fixed sequence 5 to 35:

5 - 35

The address of the memory location last called is output in the right-hand half of the AMPLITUDE display for the period that the SEQ or SET SEQ key is pressed.

The address of the memory location is output in the right-hand half of the AMPLITUDE display during an automatic sequence.

Explanations: The sweep starts with a recall at the start frequency f_{START} if the Single Sweep or Sweep Auto mode is switched on in a stored setting. A complete sweep is triggered by each recall in the case of Sweep Single independent of the set sequence set time. The sweep cancels the auto sequence timing function for the duration of the sweep. The automatic sequence continues with the auto sequence timing at the end of the sweep.

The sweep is terminated either automatically in the case of Single Sweep or by pressing one of the sweep keys: MAN, OFF, RESET, or the keys RF or AF.

2.3.37 Special Functions

The special functions enable settings to be made other than those indicated by the keyboard labels.

The special functions are switched on and off using codes (data input) (see Table 2-4).

All special functions are switched off using code 0.

All special functions are also switched off by INSTRUMENT PRESET.

Examples		a) Switching on the special function "Non-interrupting level setting" b) Switching off the special function "Non-interrupting level setting" c) Switching off all special functions		
		PARAMETER	DATA	ENTER/UNITS
a)	SHIFT <input type="text"/>	<input type="text"/> SPECIAL	<input type="text" value="1"/>	<input type="text"/>
b)	SHIFT <input type="text"/>	<input type="text"/> SPECIAL	<input type="text" value="2"/>	<input type="text"/>
c)	SHIFT <input type="text"/>	<input type="text"/> SPECIAL	<input type="text" value="0"/>	<input type="text"/>
IEC-bus codes				
a)		ATT:FIXED or SPEC1		
b)		ATT:NORMAL or SPEC2		
c)		SPEC0		

Display: The LED of the STATUS key lights up if a special function is switched on. By pressing the status key the code of the special function is output on the FREQUENCY display (see section "Status").

Table 2-4 Codes for switching the special functions on and off

Special functions	Code	
	Switch on	Switch off
Non-interrupting level setting	1	2
Level EMF	3	4
AF amplitude	5	6
Logarithmic sweep	7	8
Sweep AF	9	10
AM two-tone	11	12
FM two-tone	13	14
ϕM two-tone	15	16
FSK modulation	17	18
Pulse modulation (code 19)	19	20
AUTO SEQ repeat	21	22
Level control without function	23	24
User Request *)	25	--
Z axis inverted	27	28
Pulse modulation (code 29)	29	30
Pulse modulation with level control voltage from table"	31	32
Low rate FM	33	34
X-voltage decreasing if fSTART>fSTOP	41	42
Fine variation starting from -20 dB	43	44
Calibration routine for "Level control voltage from table	68	--
Switch off all special functions		0
Display illumination *)	40	39
Display off *)	49	--
Clear memory *)	50	--

Further special functions for test purposes are described in the Service Manual.

Remote-control commands

The special functions are switched on or off by special remote-control commands.

Table 2-5

Special functions	Remote-control commands	
	Switch on	Switch off
Non-interrupting level setting Level EMF	ATT:FIXED	ATT:NORMAL
Logarithmic sweep	LEVEL:EMF	LEVEL
Sweep AF	SWP:MODE: ^{RF} AF:LOG	SWP:MODE: ^{RF} AF:LIN
Sweep manual INC DEC:SWP	SWP:MODE:AF: ^{LIN} LOG	SWP:MODE:RF: ^{LIN} LOG
AM two-tone	AM:DUAL: ^{AC} DC	AM:OFF
FM two-tone	FM:DUAL: ^{AC} DC	FM:OFF
ΦM two-tone	PHM:DUAL	PHM:OFF
FSK modulation	FM:FSK: ^{AC} DC	FM:OFF
Pulse modulation (code 19)	AM:PULSE	AM:OFF
Pulse modulation with level control voltage from table	PULSE:LOOKUP	PULSE:OFF
Pulse modulation (code 29)	PULSE:ON	PULSE:OFF
Level control without function	ALC:FIXED	ALC:NORMAL

*) no status display

Explanation of the individual special functions:

Non-interrupting level setting	An interrupt-free level setting is possible within a range of 20 dB. See section "Non-interrupting Level Setting".
Fine variation starting from -20 dB	Modifies the special function "Non-interrupting level setting". See section "Non-interrupting Level Setting".
Level EMF	Display of EMF voltage. See section "Level EMF".
AF amplitude	The amplitude of the AF signal can be set between 1 mV and 1 V. See section "AF Amplitude".
Logarithmic sweep	For logarithmic RF and AF sweeps. See section "Logarithmic Sweep".
Sweep AF	Frequency sweep of the AF signal. See section "Sweep (AF)".
AM two-tone	AM with internal and external modulation signals. See section "Modulation, Two-tone".
FM two-tone	FM with internal and external modulation signals. See section "Modulation, Two-tone".
ϕ M two-tone	ϕ M with internal and external modulation signals. See section "Modulation, Two-tone".
FSK modulation	For external frequency-shift keying with TTL signal. See section "Modulation, FSK".
Low Rate FM	Extends the modulation frequency range for FM EXT AC to 3 Hz to 100 kHz. See section "Modulation, FM".
Pulse modulation	For external pulse modulation with TTL signal. See section "Modulation, PM".
Pulse modulation with level control voltage from table	For external pulse modulation with TTL signal. See section "Modulation, PM".
Calibration routine for level control voltage from table	After entering the switch-on code, the table with the correction values of the level control voltage is updated. See section "Modulation, PM".
AUTO SEQ repeat	Automatic sequence with automatic restart after each sweep. See section "Sequence".
Level control without function	Sample-and-hold mode of level control for increased signal-to-intermodulation ratio with multi-transmitter measurements. See section "Level Control Without Function".

User Request	When entering the switch-on code of this special function, the user causes a Service Request in Local mode via the IEC bus. This special function does not lead to a status display. See section "Service Request and Status Register".
X-voltage decreasing if fSTART > fSTOP	Signal of X-output is decreasing during sweep if fSTART > fSTOP. See section "Sweep (RF, AF), X-output and Z-output".
Z axis inverted	Z-axis signal with inverted polarity
Display illumination	Background illumination of LCDs switched off.
Display off	Prevents display of the parameters frequency, modulation and level and can only be switched off without "Display off" by means of INSTR PRESET or RCL of a memory.
Clear memory	All RCL memories 0 to 50 are overwritten by default values. See section "Store-Recall".

2.3.38 Self-test

The SMG carries out a self-test on power-up and permanently during operation.

The RAM and ROM contents are checked when the instrument is switched on. If an error is detected in a stored instrument setting, this setting is overwritten by the default setting.

The most important instrument functions are automatically monitored during operation.

A faulty function determined during the self-test is indicated by the status LED and by a Service Request message. The status code to identify the error can be output in the modulation display by pressing the STATUS key 15 (see Table 2-7, status codes of errors and overrange/underrange settings in section "Status").

In addition, 36 internal test points can be scanned via the keyboard or the IEC bus and the results read out or displayed in the amplitude display. These more detailed test facilities are described in the Service Manual.

2.3.39 Status

The generator produces numerical status messages to identify special functions and errors.

The status codes of special functions are output in the frequency display. The status codes of errors (input or function errors) are output in the modulation display. They can also be scanned via the IEC bus (see section "Error Handling"). The meanings of the status codes are described in Tables 2-6 and 2-7.

Operation: The status codes are output in the frequency and modulation displays as long as the STATUS key is pressed. If several status messages are applicable, the codes are automatically output repeatedly if the STATUS key is pressed continuously or are output one after the other every time the STATUS key is stroked.

In addition, the options fitted in the instrument are displayed in the AMPLITUDE display by pressing the STATUS key

OP. 1.2.3

Display: The STATUS LED lights up continuously if special functions are switched on or after overrange/under-range settings.

The STATUS LED flashes continuously in the case of function errors.

The STATUS LED flashes briefly in the case of input errors.

The status codes of the special functions are output in the frequency display in the following form:

SPECIAL 5

The code is 0 if no special function is switched on.

The status codes of the function errors and the over-range/underrange settings are output in the modulation display in the following form:

Err. 2

The code is 0 if no error is present.

The status codes of the input error appear briefly in the modulation display in the following form:

Err. 51

IEC bus: A Service Request message (SRQ) is output in the case of input errors, overrange/underrange settings as well as function errors. The type of error can be recognized from the event status register. The status code can be read out to enable exact error identification (see section "Error Handling").

Table 2-6 Status codes of the special functions

Code	Meaning
0	No special function switched on
1	Non-interrupting level setting
3	Level EMF
5	AF amplitude
7	Logarithmic sweep
9	Sweep AF
11	AM two-tone
13	FM two-tone
15	ϕ M two-tone
17	FSK modulation
19	Pulse modulation (code 19)
21	AUTO SEQ repeat
23	Level control without function
27	Z axis inverted
29	Pulse modulation (code 29)
31	Pulse modulation with level control voltage from table
33	Low rate FM
41	X-voltage decreasing if fSTART > fSTOP
43	Fine variation starting from -20 dB

The status codes of special functions for test purposes are described in the Service Manual.

Table 2-7 Status codes of errors and overrange/underrange settings

Code	Meaning
0	No error
Function errors	
1	Reference loop not in synchronization
2	Sum loop not in synchronization
3	FM loop not in synchronization
4	Main oscillator loop not in synchronization
5	Level control not in function
6	Battery voltage too low
7	ROM data error
8	RAM data error
9	External overvoltage at RF output
10	Error in calibration table for special function 31
Input errors	
50	Syntax errors
51	Numerical input outside permissible range
52	Illegal setting combination
53	Deviation input too large with set RF
54	RF input illegal with set deviation
55	Illegal input with standard AF generator
56	Illegal sequence entry
57	Invalid code for special functions
58	Invalid IEC-bus address
59	Input illegal because of missing option
Overrange/underrange settings	
70	Level >13 dBm
71	AM not specified with set level
72	AM not specified for AF >50 kHz
73	φM not specified for AF >10 kHz
74	RF <100 kHz
75	AF <10 Hz
76	AM EXT signal out of tolerance
77	FM/φM EXT signal out of tolerance
78	No sweep possible if step width > sweep range

2.3.40 Instrument Preset

The instrument is set to a defined basic status by pressing the keys SHIFT — INSTR PRESET.

Table 2-8 Default status

	Setting
Reference frequency	Internal
RF	100 MHz
RF amplitude	-30 dBm
Set parameter	RF
Offset	Switched off
Modulation	Switched off
AF	Switched off
Sweep (RF)	Switched off
Sweep (AF)	Switched off
Auto sequence repeat	Switched off
Variation, Δ REF function	Switched off
Variation, HOLD function	Switched off
Special functions	Switched off
Status and mask register of Service Request function	Unchanged
IEC-bus address	Unchanged

	Preset to
Variation step size	FINE
RF step	1 MHz
RF amplitude, step	0.1 dB
AF	1 kHz
AF step	0.1 kHz
AM modulation depth	30%
AM step	1%
FM deviation	10 kHz
FM step	1 kHz
ϕ M deviation	1 rad
ϕ M step	0.1 rad
Offset	0
RF sweep, start frequency	1 MHz
RF sweep, stop frequency	1000 MHz
RF sweep, step lin/log	1 MHz/1%
RF sweep, time/step	10 ms
AF sweep, start frequency	1 kHz
AF sweep, stop frequency	100 kHz
AF sweep, step lin/log	1 kHz/1%
AF sweep, time/step	10 ms
Memory locations	Unchanged
Sequence	Unchanged
Time/step sequence	Unchanged

2.3.41 IEC-bus Address

The IEC-bus address can be displayed and set using the keys. It is stored until overwritten by a new address. The address range is from 0 to 30. The SMG is set to address 28 when delivered.

Examples		a) Output IEC-bus address on display		b) Set IEC-bus address 7	
			DATA		ENTER/UNITS
a)	SHIFT []	[] IEC ADDR			
b)	SHIFT []	[] IEC ADDR	[7]		[]

Display: The IEC-bus address is output in the frequency display as long as the IEC ADDR 12 key is pressed provided the SHIFT key is pressed first.

2.4 Remote Control of Instrument via IEC Bus

The SMG is fitted with an IEC-bus connection as standard. The interface corresponds to the IEC 625-1/IEEE 488 standard. In addition, a further standard recommended by the IEEE and also accepted by the IEC commission has also been taken into consideration. This includes a description of the data transmission formats and general commands.

2.4.1 Interface Description

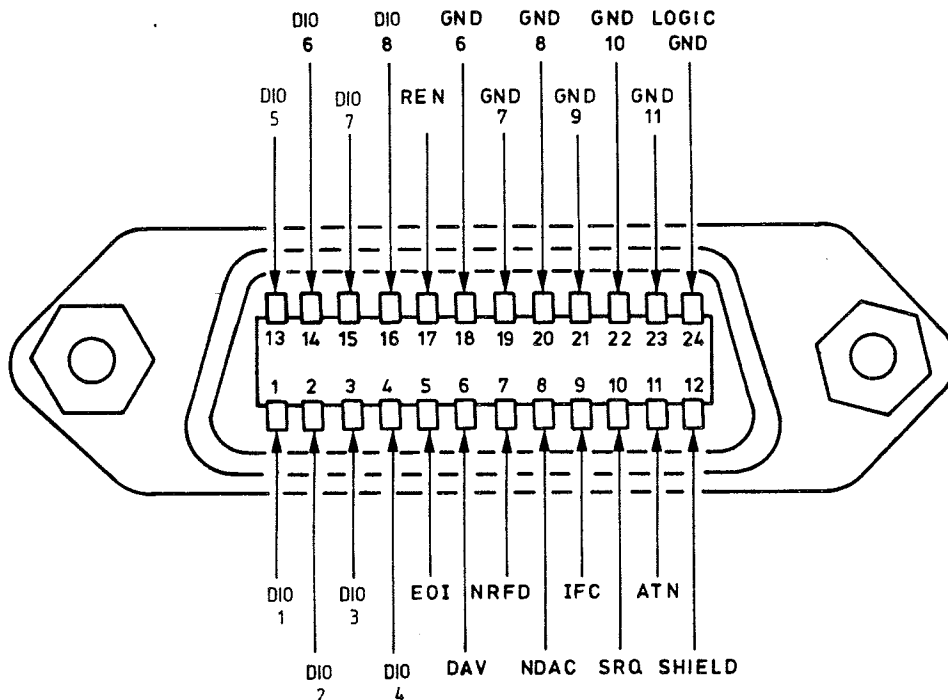

Fig. 2-13 Pin assignments

The bus connector 19 is located on the rear panel. The SMG is fitted with the 24-contact socket according to the IEEE 488 standard.

The standardized interface contains three groups of bus lines:

1. **Data bus** with 8 lines DIO 1 to DIO 8.

Data transmission is bit-parallel and byte-serial and the characters can be transmitted in ISO 7-bit code (ASCII code).

DIO 1 represents the least significant bit and DIO 8 the most significant bit.

2. Control bus with 5 lines.

This is used to transmit control functions:

ATN (Attention)	becomes active Low during transmission of addresses, universal commands or addressed commands to the connected devices.
REN (Remote Enable)	enables device to be switched to remote control.
SRQ (Service Request)	enables a connected device to send a Service Request to the controller by activating this line.
IFC (Interface Clear)	is activated by controller in order to set the IEC interfaces of the connected devices to a defined output status.
EOI (End or Identify)	can be used to identify the end of data transmission and is used with a parallel poll.

3. Handshake bus with 3 lines.

This is used to control the data transmission sequence.

NRF (Not Ready for Data)	an active Low on this line signals to the talker/controller that one of the connected devices is not ready to accept data.
DAV (Data Valid)	is activated by the talker/controller shortly after a new data byte has been applied to the data bus.
NDAC (Not Data Accepted)	is held at active Low by the connected device until the device has accepted the data present on the data bus.

More detailed information, such as the data transmission timing, can be obtained from the IEC 625-1 standard ¹⁾.

¹⁾ Order designation "DIN IEC 625" Beuth Verlag, Berlin

According to the IEC 625-1 standard, devices with remote control via the IEC bus can be equipped with different interface functions. Table 2-9 lists the interface functions which apply to the SMG:

Table 2-9 Interface functions

SH1	Source Handshake, complete ability
AH1	Acceptor Handshake, complete ability
L4	Listener function, complete ability, unaddressing if MTA
T6	Talker function, complete ability, ability to reply to serial poll, unaddressing if MLA
SR1	Service Request, complete ability
PPØ	Parallel Poll function, not available
RL1	Remote/local switchover function, complete ability
DC1	Device Clear, complete ability
DTØ	Device Trigger, not available
CØ	Controller function, not available

2.4.2 Setting the Device Address

The key IEC ADDR 12 enables the address to be displayed and set under which the device is addressed via the IEC bus, as already described in the section "IEC-bus Address".

The address is the decimal equivalent of bits 1 to 5 of the talker or listener address. This form is also used with the IEC-bus commands of the controllers.

2.4.3 Local/Remote Switchover

The device is in local (manual operation) when switched on.

If the SMG is addressed by a controller as a listener (with R&S controllers by the BASIC commands IECOUT or IECLAD), it enters the remote status (remote control) in line with the standard and remains in this status when data transmission has been finished. This is indicated by the REMOTE-LED 12. All front panel controls except the LOCAL key 13 are inhibited.

There are two possibilities to return to local:

- By the addressed command GTL (Go to Local) from the controller.
- By pressing the LOCAL key. Data output from the controller to the SMG should be stopped before pressing the LOCAL key or the SMG will immediately enter the remote status again. The function of the LOCAL key can be inhibited from the controller by sending the universal command LLO (Local Lockout).

The remaining device settings are not modified by a change in status from remote to local or vice versa.

2.4.4 Interface Messages

Interface messages (according to IEC 625-1/IEEE 488 standard) are transmitted to the SMG on the data lines with the attention line being active (Low).

2.4.4.1 Universal Commands

The universal commands are in the code range 10 to 1F hex. (see Table 2-12). They are effective, without previous addressing, on all devices connected to the bus.

Table 2-10

Command	BASIC command with R&S controllers	Effect on SMG
DCL (Device Clear)	IECDCL	Aborts processing of commands just received and sets the command processing software to a defined initial status. The device settings are not changed.
LLO (Local Lockout)	IECLLO	The LOCAL key is inhibited.
SPE (Serial Poll Enable)	IECSPE ¹⁾	Ready for Serial Poll.
SPD (Serial Poll Disable)	IECSPD ¹⁾	End of Serial Poll.

¹⁾ The BASIC command "IECSPL addr, status" contains the commands "IECSPE" and "IECSPD" and additionally reads the status of the device with address "addr" and stores it in the integer variable "status".

2.4.4.2 Addressed Commands

The addressed commands are in the code range 00 to 0F hex. (Table 2-12). They only act on devices addressed as Listeners (by the BASIC command "IECLAD addr").

Table 2-11

Command	BASIC command with R&S controllers	Effect on SMG
SDC (Selected Device Clear)	IECSDC	Aborts processing of commands just received and sets the command processing software to a defined initial status. The device settings are not changed.
GTL (Go to Local)	IECGTL	Switchover to local status (manual operation).

Table 2-12 ASCII/ISO and IEC character set

CONTROL					NUMBERS SYMBOLS				UPPER CASE				LOWER CASE				
0	NUL		16	DLE		32	SP	48	0	64	@	80	P	96	'	112	p
1	SOH	GTL	17	DC1		33	!	49	1	65	A	81	Q	97	a	113	q
2	STX		18	DC2		34	"	50	2	66	B	82	R	98	b	114	r
3	ETX		19	DC3		35	#	51	3	67	C	83	S	99	c	115	s
4	EOT	SDC	20	DC4	DCL	36	\$	52	4	68	D	84	T	100	d	116	t
5	ENQ	PPC	21	NAK	PPU	37	%	53	5	69	E	85	U	101	e	117	u
6	ACK		22	SYN		38	&	54	6	70	F	86	V	102	f	118	v
7	BEL		23	ETB		39	'	55	7	71	G	87	W	103	g	119	w
8	BS	GET	24	CAN	SPE	40	(56	8	72	H	88	X	104	h	120	x
9	HT	TCT	25	EM	SPD	41)	57	9	73	I	89	Y	105	i	121	y
10	LF		26	SUB		42	*	58	:	74	J	90	Z	106	j	122	z
11	VT		27	ESC		43	+	59	:	75	K	91	[107	k	123	{
12	FF		28	FS		44	,	60	<	76	L	92	\	108	l	124	
13	CR		29	GS		45	-	61	=	77	M	93]	109	m	125	}
14	SO		30	RS		46	.	62	>	78	N	94	^	110	n	126	~
15	SI		31	US		47	/	63	? UNL	79	O	95	-	111	o	127	DEL
ADRESSED COMMANDS		UNIVERSAL COMMANDS			LISTEN ADDRESSES				TALK ADDRESSES				SECONDARY ADDRESSES OR COMMANDS				

Key:

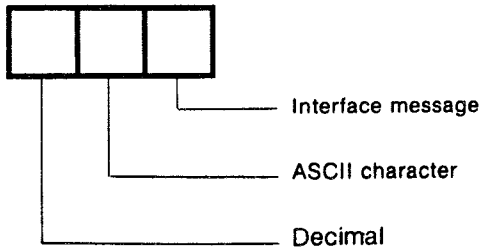

2.4.5 Device Messages

Device messages (to IEC 625-1) are transmitted on the data lines with the attention line being High, i.e. not active. The ASCII code (ISO 7-bit code) is used (see Table 2-12).

The device messages can be divided according to two different factors as shown in the following table.

Table 2-13

Device dependence	Transmission direction	Message received by SMG	Message transmitted by SMG
General, common commands (according to standard)		See Table 2-14	See Table 2-15
Device-specific commands (dependent on device functions)		See Table 2-16	See Table 2-17

Messages received by the SMG will be denoted as commands in the following.

2.4.5.1 Commands Received by the SMG in Listener Mode (controller to device messages)

Fig. 2-14 shows the syntax of a command line (program message). Each command line must be terminated by an end character; permissible end characters are:

- New line (ASCII code 10 decimal)
- End (EOI line active) together with:
 - + the last useful character of the command line or
 - + the character "New line" or
 - + the semicolon (;).

The combination "Carriage return + new line" is also permissible because the "Carriage return" character (ASCII code 13 decimal) is permissible as a filler before the end character without effect.

All IEC-bus controllers from Rohde & Schwarz transmit an end character which is accepted by the SMG.

A command line may require more than one line on the screen of the controller because it is only limited by the end character. Most IEC-bus controllers automatically hang the end character onto the useful text.

A command line may contain several **commands** (program message units) separated by **semicolons (;)**. For reasons of compatibility, the SMG also accepts a comma for this purpose (see Section "Alternatives for the Command Syntax").

A command can consist of the following parts:

- Only a header

Example: PRESET

- Header and question mark

Example: RF?

This combination requests the SMG to provide the required data in an output buffer in order to transmit them via the IEC bus as soon as the SMG is addressed as a talker (see Section "Messages Transmitted by SMG in Talker Mode").

- Header and number

Examples: RF 123.5E6; RF 123.5MHZ; RECALL 7

According to the standard, the header and number(s) must be separated by at least one space (ASCII code 32 decimal). It is permissible with the SMG to omit this space to enable compatibility with other devices. In the case of the device-specific commands, the number can be supplemented by a unit.

The headers and their significance are described in Sections "Common Commands" and "Device-specific Commands".

Lower-case letters are permissible and are equivalent to the corresponding upper-case letters. Thus units can be used in the usual form (example: dBm) instead of the upper-case notation (example: DBM) which is also permissible.

Additional spaces may be entered at the following positions:

- + before a header,
- + between header and number,
- + before and after a comma (,) and semicolon (;),
- + before the end character.

Only **decimal numbers** are permissible with the following notations:

Examples:

- With or without sign. 5, +5, -5
- With or without decimal point; the position of the decimal point is optional. 1.234, -100.5, .327,
- With or without exponent to base 10; "E" or "e" is used as the exponent character. .451, 451E-3, +4.51e-2
- The exponent is permissible with or without a sign; a space is also permissible instead of the sign. 1.5E+3, 1.5E-3, 1.5E 3
- Leading zeros are permissible in the mantissa and exponent. +0001.5, -01.5E-03
- The length of the number including the exponent may be up to 20 characters. The number of digits of the mantissa and exponent is only limited by this condition. Digits which exceed the resolution of the device are rounded up or down; they always contribute to the order of magnitude (power of ten). 150000000, 0.00000032

Note: An exponent alone (e.g.: E-3) is not permissible; 1E-3 is correct.

Indices

An index consists of at least one digit (leading zeros are permissible, decimal point and exponent notation are not permissible).

The following IEC-bus commands require an index to be entered:

1. STORE index
2. RECALL index
3. TEST:POINT index

Command line

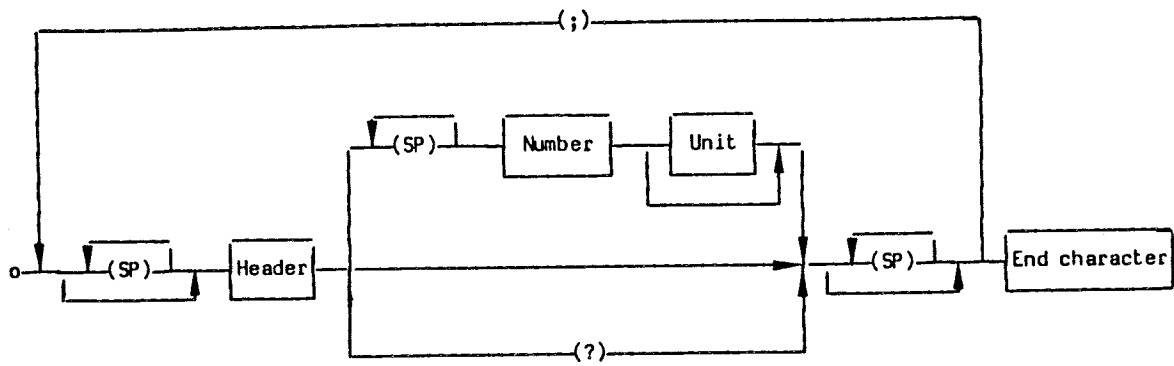

Number

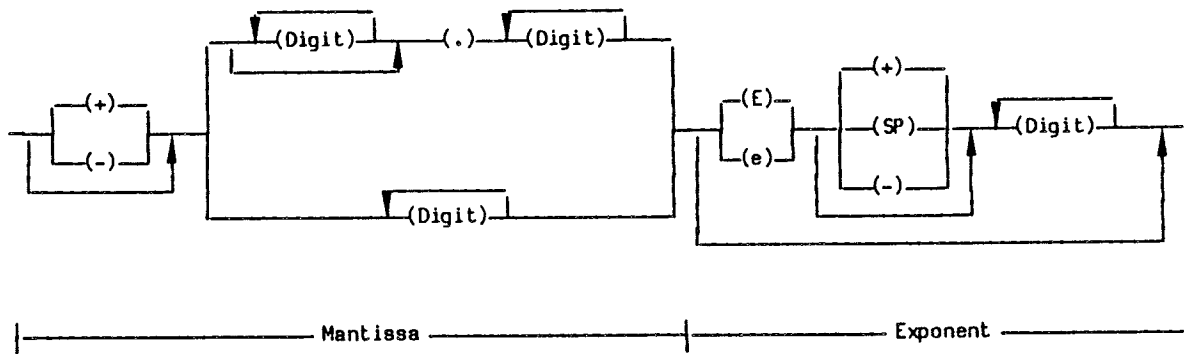

SP: Any character of ASCII code 0 to 9 or 11 to 32 decimal, especially space.

Fig. 2-14 Syntax diagram of a command line

Examples:

```
*RST; RF 108.53MHZ; LEV -15DBM; FM 12.5E3; AF 3E+3 <CR><NL>
```

|
 | New Line
 | Carriage Return

```
*HDR Ø; RF?; FM? <NL>
```

|
 | New Line

2.4.5.2 Messages Transmitted by SMG in Talker Mode (device to controller messages)

The SMG transmits messages via the IEC bus if:

1. it is requested to provide data in its output buffer by one or more data requests (query messages) with a question mark (within one line) and
2. indicates by setting bit 4 in the status byte (MAV - message available) that the required data are now present in the output buffer (see also Section "Service Request and Status Register") and
3. has been addressed as a talker
(BASIC command "IECIN addr, string variable").

It must be noted that the command line with the data requests must be transmitted immediately before the talker is addressed; the output buffer is cleared if a further command line is entered in between.

If the SMG is immediately addressed as a talker following the data request without observing point 2, the bus handshake is blocked until the requested data are available. This simple method of synchronization is meaningful with the SMG since only a few milliseconds are required to execute a data request.

The syntax of messages sent by the SMG is shown in Fig. 2-15. The syntax is similar to that for commands received by the SMG.

- "New line" (ASCII code 10 decimal) together with "End" (EOI line active) is used as the **end character**. It is also possible to set "Carriage return + new line + end" (using command TALK_TERMINATOR:CR_NL-END).
- The command "*HDR 0" or "*HDR 1" can be used to select whether **only the numbers** (*HDR 0) or the **header and numbers** (*HDR 1) are to be transmitted.

The setting "Header and numbers" can also be selected by

- + the command "*RST" (reset) or
- + by switching on the operating voltage.

The setting "Header and numbers" enables the messages transmitted by the SMG to be returned to the SMG as unmodified commands. It is then possible to read a setting entered via the keyboard, store it in the controller and repeat it later via the IEC bus.

- If the SMG contains several data requests, it also returns **several messages** within one line which are separated by **semicolons (;)**.
- **Several numbers** can be transmitted as a reply to the queries SPECIAL_FUNCTION? and ERRORS? and are separated by **commas (,)**.
- Headers and numbers are always separated by a **space**.
- The **headers** only consists of upper-case letters and the characters ":", "-", and "*".
- The syntax of the **numbers** is shown in Fig. 2-15. Only decimal numbers are transmitted. The exact form of the numbers for each message can be obtained from Tables 2-15 and 2-17.
- Messages transmitted by the SMG do not contain **units**. In the case of physical variables, the numbers are referred to the basic unit specified in Table 2-17.

Program examples

(For the IEC-bus controller PCA; the IEC-bus address of the SMG has been assumed to be 27.)

Example 1: Frequency scan; simple synchronization method

```

5 IECTERM 10 _____ Input terminator: LF
10 IECOUT27,"*HDR 0" _____ Setting: no header
20 IECOUT27,"RF?" _____ Data request: frequency
30 IECIN27,F$ _____ Read talker address and
40 PRINT "Frequency of SMX:",F$ data

```

Example 2: Frequency scan; indication through Service Request that data are available.

```

5 IECTERM 10 _____ Input terminator: LF
10 ON SRQ GOSUB 100 _____ Branch to line 100 with
Service Request.
20 IECOUT27,"*SRE 16, *HDR 0" _____ SRQ by MAV bit
30 IECOUT27,"RF?" _____ Setting: no header
. _____ Data request: frequency
.
.
100 REM ---SERVICE REQUEST ROUTINE ---
110 IECSP27,S% _____ Serial Poll
120 IF S% <> (64+16) THEN GOTO 150 _____ Service Request from SMG?
130 IECIN27,F$ _____ Yes, read talker address,
140 PRINT "Frequency of SMG:",F$ data.
150 ON SRQ GOSUB 100
160 RETURN

```

Output message line

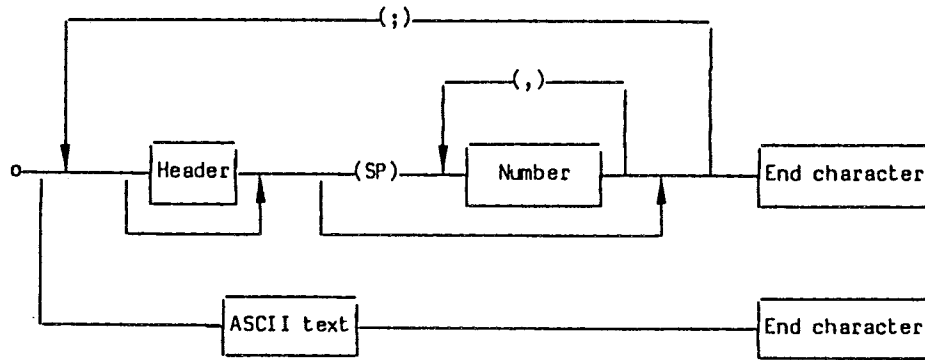

Number

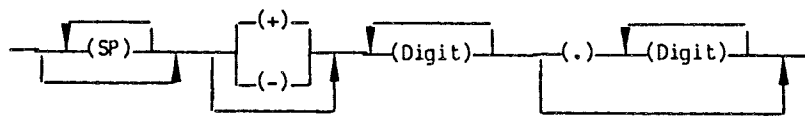

SP: Space (ASCII code 32 decimal)

ASCII text: Reply to commands "*IDN?" and "*OPT?"
(see Table 2-15)

Fig. 2-15 Syntax diagram of messages transmitted by SMG

Example with header:

RF 108530000;LEVEL -15.0;AM:OFF;FM:INT 12500<NL+END>
|
End character

Example without header:

108530000; -15.0;;12500<NL+END>
|
End character

2.4.5.3 Common Commands

These commands are listed in Tables 2-14 and 2-15.

They affect the following areas:

- Reset commands
- Commands which refer to the Service Request function with the associated status and mask registers
- Commands for device identification.

The commands have been taken from the standard. The standard ensures that these commands have the same effect in different devices.

The headers of these commands consist of a star (*) followed by 3 letters.

Table 2-14 Common commands received by the SMG

Command	Number, range	Meaning
*RST	-	<p>Reset</p> <p>Acts like the INSTR PRESET key (see Section "Instrument Preset") and</p> <ul style="list-style-type: none"> → switches to message with header (like command *HDR 1), → sets the end character in talker mode to "New Line + End", → clears the output buffer. <p>Does not change the status of the IEC-bus interface, the set IEC-bus address and the registers of the Service Request function.</p> <p>A current Service Request is only reset if caused by a message in the output buffer.</p>
*PSC	0 or 1	<p>Power On Clear flag</p> <p>If 1: The Service Request Enable mask register (SRE) and the Event Status Enable mask register (ESE) are also cleared when the instrument is switched on.</p> <p>If 0: The above-mentioned registers retain their contents even when the instrument is switched off and on. This enables a Service Request when the instrument is switched on.</p>
*HDR	0 or 1	<p>Header</p> <p>If 1: All messages from SMG to controller are transferred with a header.</p> <p>If 0: A header is not transferred with the above-mentioned messages.</p> <p>Is also set to 1 by switching on the operating voltage and by the command "*RST".</p>
*OPC	-	<p>Operation Complete</p> <p>Sets bit 0 (Operation Complete) in the Event Status register if all previous commands have been processed (see Section "Timing of Command Processing and Synchronization").</p>
*CLS	-	<p>Clear Status</p> <p>Sets the Event Status Register (ESR) to zero. The mask registers of the Service Request function (ESE and SRE) are not changed.</p>
*ESE	0 to 511	<p>Event Status Enable</p> <p>The Event Status Enable mask register is set to the specified value interpreted as a decimal number *).</p>
*SRE	0 to 255	<p>Service Request Enable</p> <p>The Service Request Enable mask register is set to the specified value interpreted as a decimal number *).</p>

*) See Section "Service Request and Status Register"

Table 2-15 Common commands which request the SMG to output messages on the IEC bus

Data request command	Output message			Meaning
	Header	Data value		
		No. of digits	Range	
*IDN?	-	23	(alpha-numeric)	<p>Identification Query</p> <p>The following identification text is transmitted via the IEC bus (always without header) as a reply to the command "*IDN?".</p> <pre> R O H D E & S C H W A R Z , S M G , 0 , 1.0 Manufacturer Model Firmware release (example) Reserved for serial No., not used in SMG </pre>
*OPT?	-	1 to 8	(alpha-numeric)	<p>Option Query</p> <p>Transmits information on the fitted options via the IEC bus (always without header).</p> <p>B1 or B2 or B3: Depends on which option is fitted. B1,B2,B3: If all options are fitted. 0: If no option is fitted.</p>
*PSC?	*PSC	1	0 or 1	<p>Power On Clear Query</p> <p>To read the status of the Power On Clear Flag, see "*PSC" in Table 2-14.</p>
*HDR?	*HDR	1	0 or 1	<p>Header Query</p> <p>To read the status of the Header flag, see "*HDR" in Table 2-14.</p>
*OPC?	*OPC	1	1	<p>Operation Complete Query</p> <p>The message "*OPC 1" or only "1" (depending on the status of the Header flag) is entered into the output buffer and bit 4 (message available) in the status byte is set if all previous commands have been processed. In addition, bit 0 (operation complete) in the Event Status Register is set (see Section "Timing of Command Processing and Synchronization").</p>
*ESR?	*ESR	3	0 to 511	<p>Event Status Register Query</p> <p>The contents of the Event Status Register are output in decimal and the register is then set to zero.</p>
*ESE?	*ESE	3	0 to 511	<p>Event Status Enable Query</p> <p>The contents of the Event Status Enable mask register are output in decimal.</p>
*STB?	*STB	3	0 to 255	<p>Status Byte Query</p> <p>The contents of the status byte are output in decimal.</p>
*SRE?	*SRE	3	0 to 255	<p>Service Request Enable Query</p> <p>The contents of the Service Request Enable mask register are output in decimal.</p>

2.4.5.4 Device-specific Commands

All SMG functions set using the keyboard can also be controlled via the IEC bus. The effect of the commands is the same as the corresponding entry via the keyboard.

The following commands have no equivalent key entry; it is a different notation for special functions:

ATT:FIXED

ATT:NORMAL

LEVEL:EMF

SWP:MODE:RF:LIN
LOG

SWP:MODE:AF:LIN
LOG

AM:DUAL:AC
DC

FM:DUAL:AC
DC

PHM:DUAL

FM:FSK:AC
DC

AM:PULSE

ALC:FIXED

ALC:NORMAL

INCREMENT:SWP

DECREMENT:SWP

PULSE:LOOKUP

PULSE:ON

PULSE:OFF

According to the display, the values of all setting parameters and information on errors (ERRORS?) and internal voltage values (TEST:VOLTAGE?) can be read in via the IEC bus.

Table 2-16 lists the setting commands and Table 2-17 the data request commands with the associated message sent by the SMG.

The **headers** are the same as the respective key inscription or similar. This results in easily readable (self-documenting) programs.

The headers can be **shortened** as desired by omitting the last characters (e.g.: L or LEV instead of LEVEL). The shortest possible notation is shown by underlining in Tables 2-16 and 2-17.

Many headers consist of several parts separated from each other by colons (:) ¹⁾ (e.g.: LEVEL:OFF). The abbreviations can be used for each part of the header separately (e.g.: LEV:OF).

Certain headers contain the underline character (ASCII code 95 decimal) to facilitate reading. It must be written like the letters but is always located in the part which can be omitted by abbreviating ²⁾.

All setting commands which can be assigned a number are identified in Table 2-16 in column "Number". These commands may also have a meaningful function without a number. For example "AM:EXTERNAL" means selection of the external modulation source where the stored AM modulation depth is retained. "AM:EXTERNAL 30", on the other hand, also sets a new modulation depth.

With the setting commands the number can be directly followed by a unit ¹⁾ (e.g. 125.3MHZ, also permissible is 125.3E3KHZ). The permissible units are listed in Table 2-16. They can also be abbreviated and written with lower-case or upper-case letters. If no unit is entered, the respective default unit applies (Hz, dBm, dB_μV, %, dB, V, Rad, sec), see Table 2-16.

¹⁾ For reasons of compatibility the SMG also permits other ways of separating the header parts and positioning the units within the command (see Section "Alternatives for the Command Syntax").

²⁾ The underline character is generated in the R&S Controllers PCA and PUC using the "+" key.

Table 2-16 Device-specific commands

The shortest possible notation is indicated by underlining.

Header	Number	Permissible units	Default unit	Explanation
<u>AF</u>	Value			AF setting
<u>AF:START</u> <u>AF:STOP</u> <u>AF:STEP</u> <u>AF:VAR_STEP</u>	1) Value	GHz MHz kHz <u>Hz</u>	Hz	AF sweep parameter AF variation step width
<u>AF:LOG_STEP</u>	1) Value	% <u>PCT</u>	%	AF sweep, logarithmic step width
<u>AF:ON</u>				Switch on AF signal to stored values of frequency and voltage
<u>AF:OFF</u>	2)			Switch off AF signal
<u>ALC:FIXED</u>				Automatically switches on special funct. "Level control without function". Level setting is retained as described under LEVEL...
<u>ALC:NORMAL</u>				Level control switched on, automatically switches off special function "Level control without function".

1) Only permissible with option SMG-B2.

2) Without function if internal modulation is switched on.

Header	Number	Permissible units	Default unit	Explanation
<u>AM</u> ³⁾	Value	$\frac{\%}{\text{PCT}}$	%	Switch on AM with selected modulation source and adjust modulation depth. Automatically switches off special functions "AM two-tone", "Level control without function" and "Pulse Modulation (code 19)".
<u>AM:EXTERNAL:AC</u> <u>AM:EXTERNAL:DC</u> <u>AM:INTERNAL</u>	Value	$\frac{\%}{\text{PCT}}$	%	As above, but adjust to stored value of modulation depth.
<u>AM:DUAL:AC</u> <u>AM:DUAL:DC</u>	Value	$\frac{\%}{\text{PCT}}$	%	Switch on two-tone AM with internal and external source (AC or DC) and adjust modulation depth. Automatically switches special function "AM two-tone" on and "Pulse modulation" off.
<u>AM:DUAL:AC</u> <u>AM:DUAL:DC</u>				As above, but adjust to stored value of modulation depth. (max. 50%).
<u>AM:PULSE</u> ⁴⁾				Switches special function "Pulse Modulation (code 19)" on and "AM two-tone" off.
<u>AM:VAR_STEP</u>	Value	$\frac{\%}{\text{PCT}}$	%	Variation step width of AM modulation depth.

³⁾ If the modulation source (INTERNAL or EXTERNAL) is not specified,

- the previous source is switched on
- or retained unchanged if AM was switched on.

⁴⁾ Only permissible with option SMG-B2.

Header	Number	Permissible units	Default unit	Explanation
<u>AM:OFF</u>				Switch off modulation and special functions "AM two-tone" and "Pulse modulation (code 19)".
<u>ATTENUATOR:FIXED</u>				For non-interrupting level setting; switches on special function "Non-interrupting level setting".
<u>ATTENUATOR:NORMAL</u>				Normal function of level setting, switches off special function "Non-interrupting level setting".
<u>DECREMENT:AF</u> <u>DECREMENT:RF</u> <u>DECREMENT:LEVEL:AF</u> _____ 5) <u>DECREMENT:LEVEL:RE</u> <u>DECREMENT:AM</u> <u>DECREMENT:FM</u> <u>DECREMENT:PHM</u> <u>DECREMENT:SWP</u>				Corresponds to key function STEP+. Entry of step width with VAR_STEP for the specified parameter.
<u>FM</u> _____ 6)	Value	<u>GHZ</u> <u>MHZ</u> <u>KHZ</u> <u>HZ</u>		Switch on FM with selected modulation source and adjust deviation. Automatically switches off special functions "FM two-tone" and "FSK modulation".
<u>FM:EXTERNAL:AC</u> <u>FM:EXTERNAL:DC</u> <u>FM:INTERNAL</u>	Value		HZ	
<u>FM:EXTERNAL:AC</u> <u>FM:EXTERNAL:DC</u> <u>FM:INTERNAL</u>				As above, but adjust to stored value of FM deviation.

5) Only permissible with option SMG-B2, automatically switches on special function "AF amplitude".

6) If the modulation source (INTERNAL or EXTERNAL) is not specified,
- the previous source is switched on
- or retained unchanged if FM was switched on.

Header	Number	Permissible units	Default unit	Explanation
<u>FM:DUAL:AC</u> <u>FM:DUAL:DC</u>	Value	GHZ MHZ KHZ HZ	HZ	Switch on two-tone FM with internal and external source (AC or DC). Automatically switches special function "FM two-tone" on and "FSK" off.
<u>FM:DUAL:AC</u> <u>FM:DUAL:DC</u>				As above, but adjust to stored value of deviation (max. 1/2 x max. deviation)
<u>FM:FSK:AC</u> ⁷⁾ <u>FM:FSK:DC</u>	Value	GHZ MHZ KHZ HZ		Switch on FM with external modulation source AC or DC (TTL signal) selected and adjust deviation. Automatically switches special function "FSK modulation" on and "FM two-tone" off.
<u>FM:FSK:AC</u> ⁷⁾ <u>FM:FSK:DC</u>				As above, but adjust to stored value of deviation.
<u>FM:VAR_STEP</u>	Value	GHZ MHZ KHZ HZ	HZ	Variation step width of FM deviation.
<u>FM:OFF</u>				Switch off modulation and special function "FM two-tone" and "FSK modulation".

⁷⁾ Only permissible with option SMG-B2.

Header	Number	Permissible units	Default unit	Explanation
<u>INCREMENT:AF</u> <u>INCREMENT:RF</u> <u>INCREMENT:LEVEL:AF</u> — ⁸), ⁹) <u>INCREMENT:LEVEL:RF</u> <u>INCREMENT:AM</u> <u>INCREMENT:FM</u> <u>INCREMENT:PHM</u> <u>INCREMENT:SWP</u>				Corresponds to key function STEP+. Entry of step width with VAR_STEP for the specified parameter.
<u>LEVEL</u> <u>LEVEL:RF</u>	Value	<u>V</u> <u>MV</u> <u>UV</u> <u>DBM</u> <u>DBUV</u>	DBM	Switch on RF level and adjust value. Automatically switches off special function "Level EMF".
<u>LEVEL:ON</u> <u>LEVEL:OFF</u> <u>LEVEL:RF:ON</u> <u>LEVEL:RF:OFF</u>				Switch on/off RF level to stored value.
<u>LEVEL:EMF</u>	Value	<u>V</u> <u>MV</u> <u>UV</u> <u>DBUV</u>	DBUV	Switch on RF level (EMF) and adjust value. Automatically switches on special function "Level EMF".
<u>LEVEL:VAR_STEP</u>	Value	<u>DB</u>	DB	Variation step width of RF level.
<u>LEVEL:OFFSET</u> <u>LEVEL:RF:OFFSET</u>	Value	<u>DB</u>	DB	Switch on RF level offset and adjust value.
<u>LEVEL:OFFSET:ON</u> <u>LEVEL:OFFSET:OFF</u> <u>LEVEL:RF:OFFSET:ON</u> <u>LEVEL:RF:OFFSET:OFF</u>				Switch on/off RF level offset to stored value.

⁸) Only permissible with option SMG-B2.

⁹) Automatically switches on special function "AF amplitude".

Header	Number	Permissible units	Default unit	Explanation
<u>LEVEL:AF</u> ¹⁰⁾	Value	$\frac{V}{MV}$	V	Switch on AF signal to stored value of frequency and adjust voltage. Automatically switches on special function "AF amplitude".
<u>LEVEL:AF:VAR_STEP</u> ¹⁰⁾	Value	$\frac{V}{MV}$	V	Variation step width of AF level.
<u>PHM</u> ¹¹⁾	Value	<u>RAD</u>	RAD	Switch on phase modulation with selected modulation source and adjust deviation. Automatically switches off special function "φM two-tone".
<u>PHM:EXTERNAL</u> <u>PHM:INTERNAL</u>				As above, but adjust to stored value of deviation.
<u>PHM:DUAL</u>	Value	<u>RAD</u>	RAD	Switch on two-tone φM with internal and external source and adjust deviation. Automatically switches on special function "φM two-tone".
<u>PHM:DUAL</u>				As above, but adjust to stored value of deviation.
<u>PHM:VAR_STEP</u>	Value	<u>RAD</u>	RAD	Variation step width of deviation.
<u>PHM:OFF</u>				Switch off modulation and special function "φM two-tone".

¹⁰⁾ Only permissible with option SMG-B2.

¹¹⁾ If the modulation source (INTERNAL or EXTERNAL) is not specified,

- the previous source is switched on
- or retained unchanged if φM was switched on.

Header	Number	Permissible units	Default unit	Explanation
<u>PRESET</u>				Set device to basic status (see Section "Instrument Preset").
<u>PULSE:ON</u>				Switch on pulse modulation (code 29).
<u>PULSE:LOOKUP</u>				Switch on pulse modulation with level control voltage from table.
<u>PULSE:OFF</u>				Switch off pulse modulation (code 29) and pulse modulation with level control voltage from table.
<u>RECALL</u>	Index			Call a stored device setting.
<u>REFERENCE_OSCILLATOR:INTERNAL</u> <u>REFERENCE_OSCILLATOR:EXTERNAL</u>				Internal reference, external reference
<u>RF</u>	Value			RF setting
<u>RF:START</u> <u>RF:STOP</u> <u>RF:STEP</u> <u>RF:VAR_STEP</u> <u>RF:OFFSET</u>	Value	$\frac{\text{GHZ}}{\text{MHZ}}$ $\frac{\text{KHZ}}{\text{HZ}}$	HZ	RF sweep parameter RF variation step width RF offset
<u>RF:LOG_STEP</u>	Value	$\frac{\%}{\text{PCT}}$	%	RF sweep, logarithmic step width
<u>RF:OFFSET:ON</u> <u>RF:OFFSET:OFF</u>				Switch on/off RF offset to stored value.
<u>STORE</u>	Index			Store device setting
<u>SWP:AUTO</u> <u>SWP:SINGLE</u> <u>SWP:MANUAL</u> <u>SWP:RESET</u> <u>SWP:OFF</u>				Switch sweep on/off. RF or AF sweep, depending on definition of sweep (see SWP:MODE). For sweep parameters, see headers AF, RF and TIME.

12) AF sweep only permissible with option SMG-B2.

Header	Number	Permissible units	Default unit	Explanation	
<u>SWP:MODE:RF:LIN</u> <u>SWP:MODE:RF:LOG</u> <u>SWP:MODE:AF:LIN</u> <u>SWP:MODE:AF:LOG</u>	12)			Definition of sweep mode. With AF sweep and logarithmic sweep, the corresponding special functions are automatically	
<u>TIME:AF_SWP</u> <u>TIME:RF_SWP</u>	13) 13)	Value	<u>SEC</u> <u>MS</u>	SEC	Definition of sweep times.
<u>TALK_TERMINATOR:NL_END</u> _____ ¹⁴⁾ <u>TALK_TERMINATOR:CR_NL_END</u>					Definition of end character in Talk mode.
<u>TEST:POINT</u>		Index			Selection of an internal test point (index 1 to 37) to measure the test voltage. ¹⁵⁾ Automatically switches on the special function "Test voltage" (see Service Manual).
<u>TEST:OFF</u>					Switches off the special function "Test voltage".

¹²⁺¹³⁾ AF sweep only permissible with option SMG-B2.

¹⁴⁾ Default setting after switching on the operating voltage and following the command *RST.

¹⁵⁾ A few test points are only available with the options installed (see Service Manual).

Table 2-17 Device-specific data request commands and messages sent from the SMG

Data request command (The shortest notation is underlined)	Message sent by SMG in talker mode					Unit (is not sent)	Explanation
	Header	Number					
		Number of characters	Sign	Decimal point	Example		
<u>AF?</u>	AF ↑↑↑↑ AF:OFF	6 0	- -	- -	12500 ↑ - *)	Hz -	AF, modulation frequency with internal modulation (standard AF generator or option SMG-B2)
<u>AF:VAR_STEP?</u>	AF:VAR	5	-	-	25 ↑↑↑	Hz	AF variation step width, (only with option SMG-B2)
<u>ALC?</u>	ALC:FIX ALC:NOR	0 0	- -	- -	- - *)	- -	Electronic level control without function (special function) Electronic level control with function (normal function)
<u>AM?</u>	AM:EXT:AC AM:EXT:DC AM:INT ↑↑↑ AM:DUA:AC AM:DUA:DC AM:PULSE ↑ AM:OFF ↑↑↑	4 4 4 4 4 0 0	- - - - - - -	x x x - x - -	37.5 8.0 ↑ 44.5 - - *) - *)	% % % % % - -	AM modulation sources and modulation depth Special function Special function Special function
<u>AM:VAR_STEP?</u>	AM:VAR	4	-	x	10.0	%	Variation step width of AM modulation depth
<u>ATTENUATOR?</u>	ATT:FIX ATT:NOR	- -	- -	- -	- - *)	- -	With "ATT:FIX", special function "Non-interrupting level setting" is switched on
<u>ATTEN:CONT?</u>	ATT:CONT	4	-	x	8.5 ↑	dB	Electronic attenuation
<u>ERRORS?</u>	ERRORS	2 per value	-	-	0 ↑ 4, 5, 51 ↑↑	-	Errr codes 0 = no error (see Table 2-7 and Section "Error Handling")
<u>FM?</u>	FM:EXT:AC FM:EXT:DC FM:INT ↑↑↑ FM:DUA:AC FM:DUA:DC FM:FSK:AC FM:FSK:DC FM:OFF ↑↑↑	7 7 7 7 7 7 7 0	- - - - - - - -	- - - - - - - -	13500 ↑↑ - - - - - *) -	Hz Hz Hz Hz Hz Hz Hz -	FM modulation sources and deviation Special function Special function Special function Special function
<u>FM:VAR_STEP?</u>	FM:VAR	7	-	-	100 ↑↑↑↑	Hz	Variation step width of FM deviation

Notes: x means present
 - means not present
 † Space
 *) A number is not transmitted; with the header switched off, only the delimiter or terminator appears.

Data request command (The shortest notation is underlined)	Message sent by SMC in talker mode					Unit (is not sent)	Explanation
	Header	Number					
		Number of characters	Sign	Decimal point	Example		
<u>LEVEL?</u> or <u>LEVEL:RF?</u>	LEVEL:RF † LEVEL:OFF	6 0	x -	x -	-105.3 +3.0 †† - *)	dBm -	RF level
<u>LEVEL:EMF?</u>	LEVEL:EMF LEVEL:OFF	6 0	x -	x -	+120.0 - *)	dBµV -	RF level as EMF
<u>LEVEL:VAR_STEP?</u>	LEVEL:VAR	5	-	x	20.0 †	dB	Variation step width of RF level
<u>LEVEL:OFFSET?</u> or <u>LEVEL:RF:OFFSET?</u>	LEVEL:OFFSET †† LEVEL:OFFS:OFF	6 0	x -	x -	-3.5 †† - *)	dB -	Offset setting of RF level
<u>LEVEL:AF?</u>	LEVEL:AF AF:OFF ††	5 0	- -	x -	0.999 - *)	V -	AF level (special function "AF amplitude")
<u>LEVEL:AF:VAR_STEP?</u>	LEVEL:AF:VAR	5	-	x	0.010	V	Variation step width of AF level
<u>PHM?</u>	PHM:EXT PHM:INT PHM:QUA PHM:OFF	7 7 7 0	- - - -	x x x -	0.999 †† 7.330 †† - *)	RAO RAO RAO -	Phase modulation, modulation sources and deviation Special function
<u>PHM:VAR_STEP?</u>	PHM:VAR	7	-	x	0.100 ††	RAO	Variations step width of phase deviation
<u>REFERENCE_OSCILLATOR?</u>	REF:INT REF:EXT	0 0	- -	- -	- *) - *)	- -	Reference oscillator internal or external
<u>RF?</u>	RF	10	-	-	100000000 100000 ††††	Hz	RF
<u>RF:VAR_STEP?</u>	RF:VAR	10	-	-	10000000 ††	Hz	Variation step width of RF
<u>RF:OFFSET?</u>	RF:OFFSET †† RF:OFFS:OFF	11 0	x -	- -	+10700000 †† - *)	Hz -	RF offset
<u>SPECIAL_FUNCTION?</u>	SPECIAL	3 per value	-	-	1, 5, †† †† 0 ††	-	Codes of all special functions switched on, 0 means no special function
<u>TEST:POINT?</u>	TEST:POINT TEST:OFF ††	2	-	-	1 †	-	Test point (1 to 37) ¹⁵⁾ (special function)
<u>TEST:VOLTAGE?</u>	TEST:VOLT	7	x	x	-15.000 -1.350 † +0.3456	V	Voltage at selected test point. (The header cannot be used for a setting.) Before the voltage is requested, the test point must be selected!

Notes: x means present
- means not present
† Space

*) A number is not transmitted; with the header switched off, only the delimiter or terminator appears.

Examples:

(The IEC-bus address of the SMG has been assumed to be 27.)

1. Basic setting

```
IECOUT27,"PRESET"           or
IECOUT27,"*RST"
```

2. Set frequency (RF) to 123.45 MHz

```
IECOUT27,"RF 123.45MHZ"     or
IECOUT27,"RF 123.45E6"      or
IECOUT27,"RF 123450000"
```

3. Using an external reference oscillator

```
IECOUT27,"REF:EXT"
```

4. Amplitude modulation of 35% with the internal generator,
modulation frequency 15 kHz

```
IECOUT27,"AF 15KHZ;AM:INT 35"
```

5. Frequency modulation by an external modulation source with a
deviation of 12.5 kHz

```
IECOUT27,"FM:EXT 12.5KHZ"
```

6. Two-tone frequency modulation, EXT AC, internal modulation
frequency 3 kHz

```
IECOUT27,"FM:DUAL:AC 6.25KHZ; AF 3KHZ"
```

7. Switch off two-tone frequency modulation

```
IECOUT27,"FM:OFF"
```

8. Set level to 120 μ V

```
IECOUT27,"LEVEL 120uV"      or
IECOUT27,"LEV 120UV"        or
IECOUT27,"L 1.2E-4V"
```

9. Adjust level to an EMF of 2 V

```
IECOUT27,"LEV:EMF 2V"
```

10. Vary the level from -8 dBm to +2 dBm in steps of 0.2 dB without interruptions.

```
10 IECOUT27,"LEV 2; ATTEN:FIXED; LEV -8; LEV:VAR 0.2"  
20 FOR I% = 1 TO 50  
30 IECOUT27,"INCR:LEV"  
40 NEXT I%
```

11. With special function "Non-interrupting level setting": read the level in dBm and the electronic attenuation in dB and output on the controller.

```
5 IECTERM 10  
10 IECOUT27,"*HDR 1; LEV?; ATTEN:CONT?"  
20 IECIN27,L$  
30 PRINT L$
```

2.4.5.5 Alternatives for the Command Syntax

In order to achieve as high a degree of compatibility with older R&S instruments, the SMG as a listener also accepts command notations which are not included in the described standard:

1. Instead of the semicolon (;), a comma (,) is also permissible as a delimiter between the commands.

Example: *RST, LEVEL -10DBM, ATTEN:FIXED, *OPC?

2. Spaces or the brackets (), [], {} are permissible instead of the colon (:) between the headers of the device-specific commands.

Examples: AM INTERNAL 30;
AM(INTERNAL) 30;
RF(OFFSET OFF);

3. The space between the header and number can be omitted.

Example: RECALL15;

4. An equal sign (=) can be inserted if required between the header and number.

Example: AM=30%;

5. The unit may be located after the header (separated by a slash (/)) and not only after the number.

Examples: RE/MHZ 108.2;
LEVEL/DBM -10.5;

6. Additional spaces are also permissible between the headers and between the sign and number.

Examples: REFERENCE (EXTERNAL) ;
LEVEL - 1.5DBM;
LEVEL /V + 8.4E- 3;

2.4.6 Service Request and Status Register

Fig. 2-16 shows the status registers and the links between them. In line with the standard, the status byte (STB) and its associated mask register (SRE), which are also present with older instruments, have been supplemented by the event status register (ESR) and its mask register, event status enable (ESE).

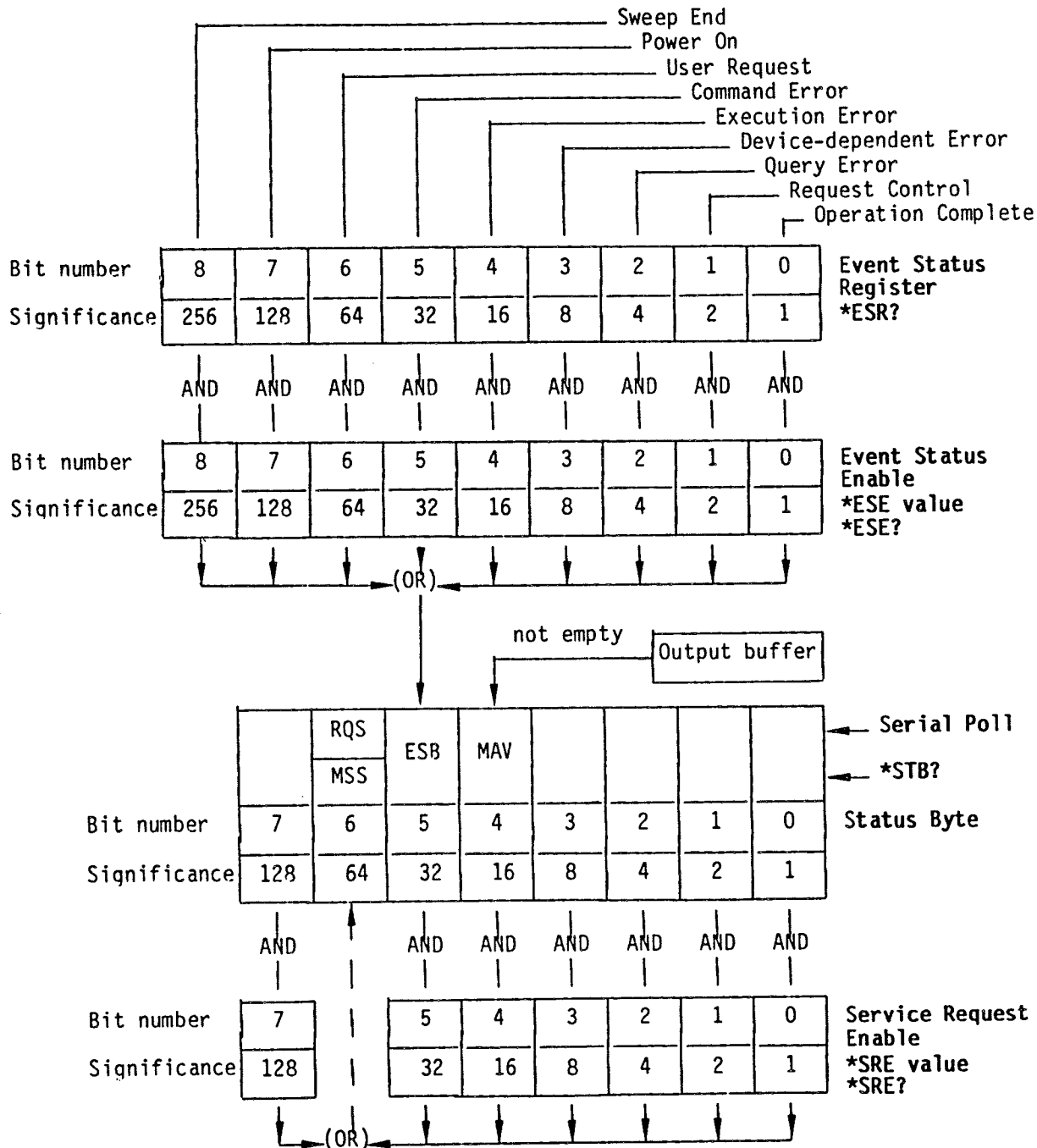

Fig. 2-16 Status registers

Table 2-15 Bit allocation of the event status register

Bit 8	Sweep End is set when the step frequency is reached in a Single Sweep.
Bit 7	Power On is set when the SMG is switched on or if the AC supply is restored after a failure.
Bit 6	User Request The operator can set this bit by activating special function 25 in the local status via the keyboard and thus initiate a Service Request with a corresponding setting of the mask register. This function is useful if test sequences require manual operation as well as control via the IEC bus.
Bit 5	Command Error This is set if a syntax error (Error 50) is detected during analysis of the received commands. This also includes the following errors: - Illegal unit - Illegal header - A number has been combined with a header for which a number is not envisaged (e.g. INCREMENT:RF 10KHZ).

<p>Bit 4</p>	<p>Execution Error</p> <p>is set if an input error or an overrange/underrange setting (code 70 to 75) has been detected during execution of the received commands (see Table 2-7).</p> <p>The combination of settings is illegal if:</p> <ul style="list-style-type: none"> - the command AF:OFF has been sent although internal modulation was still switched on, - the FM deviation or the RF cannot be set because the FM deviation is too large. The parameter value which has caused the error is not accepted. <p>Attention must be paid to the correct sequence if both the FM deviation and the RF are changed. This error may briefly occur if the sequence is incorrect and if the deviation values are large and acceptance of a parameter value is then prevented.</p>
<p>Bit 3</p>	<p>Device-dependent Error</p> <p>is set if function errors occur (errors 1 to 9, see Table 2-7) and in the case of overrange/underrange settings with code 76 or 77.</p>
<p>Bit 2</p>	<p>Query Error</p> <p>This bit is set:</p> <ul style="list-style-type: none"> - If the controller wishes to read data from the SMG but a data request has not been previously output. - If the data present in the output buffer of the SMG have not been read out and a new command has been sent to the SMG instead. In this case the output buffer is cleared.
<p>Bit 1</p>	<p>Request Control</p> <p>Not used in SMG.</p>
<p>Bit 0</p>	<p>Operation Complete</p> <p>This bit is set by the commands "*OPC" and "*OPC?" if all previous commands have been executed.</p>

A bit is set to "1" in the **event status register (ESR)** with certain events (e.g. fault, ready message); see Table 2-18.

The bits remain set until cleared by reading the event status register (by the command "***ESR?**") or by the following conditions:

- The command "***RST**"
- The power supply is switched on (the Power On bit is set afterwards, however).

Using the **event status enable mask register (ESE)**, the user can select the bits in the event status register which also set the sum bit ESB (bit 5 in the status byte) through which a service request can be triggered. The sum bit is only set if at least one bit in the ESR and the corresponding bit in the ESE are set to "1". The sum bit is automatically cleared again if the above condition is no longer satisfied, e.g. if the bits in the ESR are cleared by reading the ESR or if the ESE is changed.

The event status enable mask register is written by the command "***ESE value**" ("value" is the contents in decimal) and can be read again using the command "***ESE?**". It is set to zero when the power supply is switched on if the Power On Clear flag is 1 (***PSC 1**).

It is not changed by other commands or interface messages (DCL, SDC).

Only the following bits are used in the **status byte (STB)**:

Bit No.	Bus line	Designation	Meaning
4	DIO 5	MAV	Message available Indicates that a message is present in the output buffer which can be read. The bit is 0 if the output buffer is empty.
5	DIO 6	ESB	Sum bit of the event status register
6	DIO 7	RQS	Request Service (read by Serial Poll)
		MSS	Master Status Summary (read by *STB?)

It should be noted that the bits of the status registers are numbered 0 to 7 in accordance with the standard, but the bus data lines are designated DIO 1 to DIO 8.

Using the service request enable mask register (SRE), the user can determine whether the RQS bit of the status byte is also to be set when the MAV or ESB bit switches from 0 to 1 and if a Service Request is to be sent to the controller by activating the SRQ line. The following possibilities exist since each bit in the service request enable mask register is assigned to the corresponding bit in the status byte:

Contents of the SRE (decimal)	Set bit No. in the SRE	Effect
0	-	No Service Request
16	4	Service Request when the MAV bit is set (message in output buffer)
32	5	Service Request when the ESB bit is set (at least 1 bit set in the event status register and not masked)
48	4+5	Service Request in both of the above cases

The service request enable mask register (SRE) is written with the command "*SRE value" ("value" is the contents in decimal) and can be read again using the command "*SRE?". It is set to zero when the power supply is switched on if the Power On Clear flag is 1, and the Service Request function of the SMG is thus inhibited. The SRE mask register is not changed by other commands or interface messages (DCL, SDC).

Several devices can trigger a Service Request simultaneously, the open collector drivers cause an OR function on the SRQ line. The controller must read the status bytes of the devices to identify which device has triggered the Service Request. A set RQS bit (bit 6/DIO 7) indicates that the device is transmitting a Service Request.

The status byte of the SMG can be read in the following manner:

1. By the command "*STB?".

MSS (Master Status Summary) is transferred as bit 6. MSS is 1 if at least 1 bit in the status byte is set and the corresponding bit in the Service Request Enable mask register (SRE) is also set.

The contents of the status byte (including MSS bit) are output in decimal. It is, however, not possible to detect a set MAV bit in this manner. The status byte is not modified by reading and a possibly present Service Request is not cleared.

2. By a Serial Poll

(With R&S controllers: IEC SPL adr, status)

The contents are transferred in binary form as one byte. RQS (Service Request) is sent as bit 6. RQS is set if the addressed device has caused the Service Request. The RQS bit is subsequently set to zero and the Service Request becomes inactive, the other bits of the status byte are not changed.

When MSS is cleared, RQS is also cleared, e.g. by setting the Service Request Enable mask register (SRE) to zero.

The status byte is cleared:

1. By "*CLS" at the start of a command line. At the start of a command line, the output buffer (and thus the MAV bit) is cleared. *CLS clears the event status register (and thus the ESB bit). This again clears the MSS or RQS bit and the Service Request.
2. By handling the entries in the status byte.

With the MAV bit set: By reading the contents of the output buffer (IECIN adr, A\$)

With the ESB bit set: By reading the event status register (*ESR?)

This also clears the MSS or RQS bit in the status byte and the Service Request.

Program example:

In the following program example, a Service Request is triggered if any error is detected, and the type of error is determined from the event status register. (The instruction set of the IEC-bus controller PCA has been used; the IEC-bus address for the SMG has been assumed to be 27.)

```
10 IECTERM 10 _____ Input termina-
20 ON SRQ GOSUB 100        tor: LF
30 IECOUT27, "*CLS; *HDR 0; *ESE 60; *SRE 32"
.
.
.
100 REM -----
110 REM      SERVICE REQUEST ROUTINE
120 REM -----
130 IEC SPL 27, S%
140 IF (S% AND 64) = 0 THEN GOTO 300 _____ SRQ not from
150 IECOUT27, "*ESR?" _____ SMG?
160 IECIN27, E$           Read event
170 E% = VAL(E$)         status register
180 IF (E% AND 32) <> 0 THEN PRINT "COMMAND ERROR"
190 IF (E% AND 16) <> 0 THEN PRINT "EXECUTION ERROR"
200 IF (E% AND 8) <> 0 THEN PRINT "DEVICE-DEPENDENT ERROR"
210 IF (E% AND 4) <> 0 THEN PRINT "QUERY ERROR"
220 ON SRQ GOSUB 100
230 RETURN
240 REM -----
300 REM Service Request from other device
.
.
380 ON SRQ GOSUB 100
390 RETURN
```

2.4.7 Timing of Command Processing and Synchronization

The commands received by the SMG are first stored temporarily in an input buffer which is large enough for 80 characters. Parallel to this, the commands are processed in the sequence in which they were transmitted. After the transmission, the IEC bus can immediately be used for communication with other devices. Command lines which exceed the capacity of the input buffer are processed in several parts. The bus is occupied during this time.

The commands "***OPC**" and "***OPC?**" (Operation Complete) are used as feedbacks to indicate the time at which processing of the received commands has been finished.

***OPC** sets bit 0 in the event status register and a Service Request can then be triggered if all previous commands have been executed.

A message is also made available in the output buffer by ***OPC?** and bit 4 (MAV) in the status byte is set.

Program example:

The command "*OPC?" is used in the following program example. The message generated by it sets bit MAV in the status byte which triggers a Service Request. The generated message is not used further but is cleared again by "*CLS".

(The command set of the IEC-bus controller PCA has been used; the IEC-bus address of the SMG has been assumed to be 27.)

```
100 ON SRQ GOSUB 100
20 IECOUT27,"*RST; *CLS; *SRE 16"
30 IECOUT27,"RF 108.25MHZ; LEV 250MV; FM 10KHZ; *OPC?"
40 REM Set further devices
.
.
.
100 REM ----- SERVICE REQUEST ROUTINE -----
110 IECOUT27, S%
120 IF (S% AND 64) = 0 THEN GOTO 190
130 IECOUT27,"*CLS"
140 REM The SMG has executed the commands
150 REM in line 30. Its output signal can
160 REM be used e.g. for measurements.
.
.
.
190 ON SRQ GOSUB 100
200 RETURN
```

Reset, clear status, Service Request by MAV bit

Operation Complete?

Serial Poll
SRQ not from SMG?

Clear status and output buffer

In a similar manner, the operation complete bit in the event status register can also trigger a Service Request. Line 20 must then be:

```
20 IECOUT27," *RST; *CLS; *ESE 1; *SRE 32"
```

"*OPC" is then sufficient in line 30 instead of "*OPC?".

2.4.8 Error Handling

All errors detected by the SMG associated with operation from the IEC bus are displayed in the **event status register** (see Table 2-18) by setting a bit (bit 2, 4 or 5). Function errors are correspondingly signalled by setting bit 3. These bits remain set until the event status register is read or cleared by command "*CLS". This is in accordance with the standard and enables a Service Request to be triggered and program-controlled evaluation of the type of error.

More detailed information is contained in the **error codes** which, just like with keyboard operations, are output in the modulation display (see Table 2-7). The display may be overwritten by the next command, however, and is therefore not always visible with IEC-bus operation. It is therefore possible to read out these error codes via the IEC bus using command "ERRORS?". If several errors are present, the error codes are separated by commas. Code "0" indicates that no errors are present. Input errors are cleared if a new command line is sent to the SMG. The command "ERRORS?" must therefore be in the same line in which the error is assumed to be.

Error codes 76, 77 with **external modulation** indicate that the externally applied voltage does not have the required value. If information on the direction or the exact magnitude of the deviation is additionally required, the following command sequence must be used:

```
10 IECOUT27,"*HDR 0; TEST:POINT 6; TEST:VOLT?; TEST:OFF"  
20 IECIN27,A$
```

(Test point 6 AM input, test point 7 FM/ΦM input)

The voltage value obtained should lie between 2.57 and 2.68 V.

2.4.9 Resetting Device Functions

The following table comprises the various commands and events which reset individual device functions.

Table 2-19

Event Effect	Switch-on of operating voltage		DCL, SDC (Device Clear, Selected Device Clear)	Commands		
	Power On Clear flag 0	1		*RST	*CLS	PRESET
Basic instrument setting (see Section "Instrument Preset")	-	-	-	yes	-	yes
Set event status register ESR to zero	yes	yes	-	yes	yes	-
Set mask registers ESE and SRE to zero	-	yes	-	-	-	-
Clear output buffer	yes	yes	yes	yes	³⁾	-
Clear Service Request	yes	¹⁾	²⁾	²⁾	³⁾	-
Message from SMG: setting "With header", talker end character new line + end	yes	yes	-	yes	-	-
Reset command processing and input buffer	yes	yes	yes	-	-	-

- ¹⁾ Yes, but "Service Request on Power On" is possible.
²⁾ Yes, if only caused by message in output buffer.
³⁾ Yes, if *CLS is at the start of a command line.

2.5 Options

The following options are available:

- SMG-B1 Reference Oscillator, OCXO
- SMG-B2 AF Synthesizer
- SMG-B21 AF Synthesizer
- SMG-B3 X Output

Further details can be obtained from Sections "Internal/External Reference Frequency", "Internal AF Modulation Frequency", "AF Amplitude", "Sweep (AF)" and from the data sheet.

Retrofitting of option SMG-B1

Fit the option to the rear panel to the left of the blower (when viewed from the front) so that the subminax plug points to the bottom and the two spacers to the left side of the instrument. Fasten using the 4 screws supplied. Insert 2 screws from the side through the spacers and the countersunk screws through the rear frame from above and below.

Snap the supplied cable W8 between the subminax plug of the option and plug X202 on the module FRN LOOP (801.3917.02). The module FRN LOOP is the bottom module in the hinged frame, plug X202 is the second from the right (when viewed from the front).

Plug the ribbon cable for the power supply onto plug X31 of the power pack. Plug X31 is located at the front left corner (when viewed from the front) of the power pack board screwed to the rear panel.

Retrofitting of option SMG-B2

The option is inserted instead of the AF generator board (801.7312.02). The AF generator is the first removable board behind the front panel.

Retrofitting of Option SMG-B21

The AF synthesizer option (802.0411.04) is inserted instead of the AF generator module (801.7312.02). The AF generator is transversely installed in the instrument in an upright position behind the front panel as the first removable board. Remove the upper cover and replace the EPROMs D70 and D71 by the supplied EPROM set (843.5853) on the processor board behind the AF generator. Make sure to prevent any electrostatic charging. Attach the label "600 Ω " (843.5799) to the front panel in the vicinity of the socket "FM/ ψ mEXT" if jumper X10AB is plugged on the AF synthesizer module. Attach the label "Option AF-Synthesizer SMG-B21" to the rear panel of the instrument.

After a warmup time of approx. 1 h, the calibration table of special function 31 has to be generated. This is done by selecting the special function "Calibration routine for level control voltage from table" using code 68 and takes approx. 40 seconds. During the calibration, the readout ALC-CALibr appears in the FREQUENCY display, PULS in the modulation display, and the RF attenuator switches to -140.1 dBm.

Retrofitting of option SMG-B3

Fit the option to the rear panel to the left of the blower (when viewed from the front). Adhere the following label over the label

AM and FM/φM
EXT and EXT on the rear:

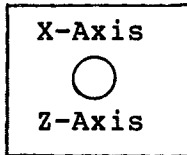

To fit the option, swivel up the hinged frame of the RF module. The RF module can be swivelled after undoing 4 countersunk screws. (Note: First unscrew cable W2 from the output stage module.)

Fit the BNC socket of cable W5 into the cut-out X-Axis and the BNC socket of cable W10 into the cut-out Z-Axis using screws. It is advisable to detach the mounting plate from the frame first in order to facilitate fastening of the BNC sockets. Insert the PCB of the option with the lugs into the cut-outs of the mounting plate at the bottom and fasten between the mounting brackets and the supporting sheet at the top using two self-tapping screws M3. The solder side of the PCB points to the blower.

Plug cable W5 onto plug X5 on the option board and cable W10 onto plug X10.

Feed the ribbon cable fastened to the option board along the bottom of the instrument to the front and plug onto plug X10 on the AF Motherboard (801.1043).

3.1 Required Measuring Equipment and Accessories

Item	Instrument	Required specifications	Order No.	Use described in section
1	Frequency counter	Range 10 Hz to 1000 MHz Resolution 1 Hz	contained in item 2	3.2.2 3.2.3 3.2.14 3.2.25
2	RF analyzer	Range 0.1 to 1500 MHz Crystal stabilized, dynamic range 90 dB	FSB 848.0020.52	3.2.4 3.2.6 3.2.8 3.2.10 3.2.12 3.2.19
3	Power meter	Range 0.1 to 1000 MHz Power up to 20 mW, Z = 50 Ω , error <0.1 dB, resolution <0.02 dB	NRVS 1020. 1809.02 NRVS-Z51 857.9004.02	3.2.5 3.2.7
4	Precision attenuation set	Range >500 MHz Attenuation 0 to 120 dB, Z = 50 Ω	DPSP 334.6010.02	3.2.6
5	Controller	IEC 625-1 interface	PSA15 1012. 1003.03	3.2.4
6	Test generator	Range up to 1000 MHz Low noise	SME02 1038. 6002.02	3.2.8 3.2.11
7	SWR bridge	Range up to 1000 MHz Z = 50 Ω	ZRB2 373.9017.52	3.2.8
8	RF analyzer	Range up to 2.8 GHz Dynamic range >40 dB	FSB 848.0020.52	3.2.9
9	Mixer	Range up to 1000 MHz Ring modulator, standard level		3.2.11
10	Lowpass filter 200 kHz	Z = 50 Ω for f >200 kHz		3.2.11
11	Instrument amplifier	Range 1 kHz to 20 kHz Gain 20 dB, inherent noise <5 nV/1 Hz test bandwidth		3.2.11

Item	Instrument	Required specifications	Order No.	Use described in section
12	AF analyzer	Range up to 20 kHz Sensitivity <3 μ V, R_{in} >10 k Ω	UPD 1030. 7500.02	3.2.11
13	Oscilloscope	DC to 5 MHz, 0.1 V/div		3.2.11
14	Adjustable lowpass filter	Half octave intervals, 30 MHz to 1360 MHz		3.2.12
15	Deviation meter	Range up to 1000 MHz Residual FM at 250 MHz <1 Hz (CCITT) <2 Hz (30 Hz to 20 kHz)	FMA 852.8500.52	3.2.13
16	Modulation analyzer	Frequency range up to 1000 MHz, AM, FM, ϕ M, error <1%, Distortion Meter, Weighting Filters CCIR, CCITT	FMA 852.8500.52 FMA-B1 855.2002.52 FMA-B2 855.0000.52	3.2.16 3.2.17 3.2.18 3.2.20 to 3.2.24 3.2.26 to 3.2.29
17	AF generator	Frequency range up to 100 kHz	AFG 377.2100.02	3.2.15 3.2.18 3.2.24 3.2.29
18	AF voltmeter	Frequency range up to 100 kHz, frequency response <0.01 dB	URE3 350.5315.03	3.2.14 3.2.15
19	Distortion meter	Frequency range up to 100 kHz, Resolution <0.05%	contained in item 16	3.2.14 3.2.17
20	Psophometer	Frequency range 15 Hz to 20 kHz RMS rectifier	contained in item 16	3.2.13
21	Power signal generator	Level 30 dBm up to 1 GHz	SMGL 1020. 2005.52	3.2.30

3.2 Testing the Performance Data

3.2.1 Display and Keyboard

The special function "Display Test" carries out a test of the displays. All displays are lit up.

The keys are tested by pressing them and their function checked against the display.

3.2.2 Frequency Setting

SMG setting: Unmodulated, level 0 dBm

Test setup:

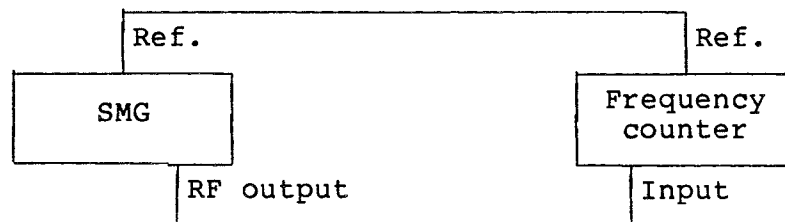

Synchronize reference frequency from SMG and from frequency counter.

Test: Set the following frequencies on the SMG and check using the frequency counter.

10 MHz	150 MHz
60 MHz	400 MHz
90 MHz	700 MHz
	1000 MHz

The values on the counter must not deviate by more than ± 1 Hz.

3.2.3 Reference Frequency

- Allow at least one hour for the instrument to warm up.
- Connect a calibrated frequency counter to output REF. FREQ. 22 (rear panel).

The relative frequency error must not exceed

2×10^{-6} /year operation + 1×10^{-5} with the standard design
 1×10^{-9} /day operation + 1×10^{-7} with the option SMG-B1
Reference Oscillator, OCXO

in the rated temperature range.

3.2.4 Settling Time

A crystal stabilized RF analyzer with a storage CRT which can be externally triggered by positive TTL edges is required to measure the settling time. The transient is made visible by edge demodulation with a 0-Hz span. Using a controller, two frequencies are set alternately on the SMG via the IEC bus. The controller should only activate the EOI line with the last data byte and must not otherwise send a terminator. The analyzer is adjusted such that one of the two frequencies lies on a filter edge. If the analyzer is triggered by the positive edge of the EOI signal, the transient appears on the CRT following the last character of the IEC-bus transmission.

Test setup:

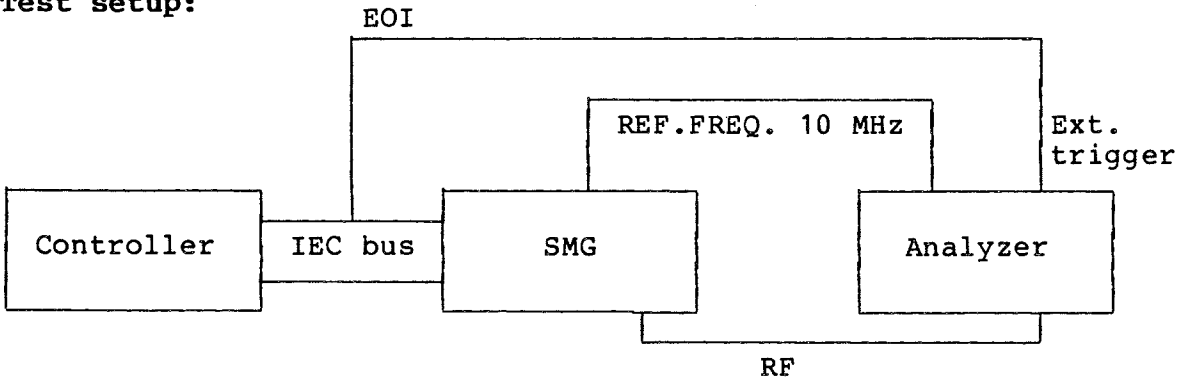

Test: Synchronize reference frequency from the SMG and the RF analyzer. Connect the IEC bus and the RF line. Connect the EOI line (pin 5 on the IEC-bus connector) to the external trigger input of the analyzer. Set the SMG to 0 dBm and to the end value of the frequency jump to be measured. Set the reference level to -5 dBm on the analyzer, the amplitude scale to 1 dB/div, the resolution bandwidths to 1 kHz and the span to 3 kHz. Increase the centre frequency until the filter edge passes through the centre point of the CRT. The span can now be reduced to 0 Hz and the scale calibrated on the CRT using frequency steps of 100 Hz. The transient response appears on the CRT if the test program is now started and the analyzer switched to external triggering. The settling time (period up to final frequency 2×10^{-7}) must be <15 ms.

It is sufficient to only measure frequencies above 500 MHz since all frequencies below 500 MHz are derived by dividing and mixing the higher octaves.

Test program: Settling time

```
10 IECTERM 1
20 IECDCCL : HOLD 500
30 IECOUT28, "LEV 0DBM"
40 INPUT "START FREQUENCY IN MHZ"; F1$
50 INPUT "STOP FREQUENCY IN MHZ"; F2$
60 IECOUT28, "RF" + F1$ + "MHZ"
70 HOLD 200
80 IECOUT28, "RF" + F2$ + "MHZ"
90 INPUT "REPEAT"; W$
100 IF W$ = "J" THEN 60
110 GOTO 40
```

3.2.5 Output Level

SMG setting: Unmodulated, level 0 dBm,
frequencies 100 kHz to 1000 MHz

Test setup: Connect power meter to RF output.

Test: The frequency response must not fall below
1 dB.

3.2.6 Attenuation Set

SMG setting: unmodulated, 100 MHz, 13 dBm

Precision attenuation set: 120 dB attenuation

Test receiver: 100 MHz, -10 dB μ V,
linear, mean value,
bandwidth 7.5 kHz

Test setup:

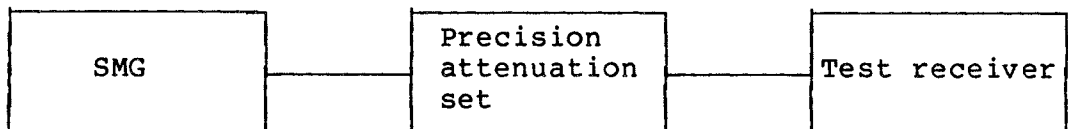

Ensure that the cable connections are RF tight.

Test: The nominal attenuation values according to the
performance test protocol must be taken into
account.

- + Note the level displayed on the test receiver as
the reference value (approx. 0 dB μ V).
- + Repeat the measurement with the settings shown
in Table 3-1.
- + The difference from the reference value must not
exceed 1 dB.

Table 3-1

SMG level dBm	Attenuation of the precision attenuation set dB
13	120
8	115
3	110
-7	100
-27	80
-47	60
-67	40
-87	20
-107	0

3.2.7 Non-interrupting Level Setting

SMG setting: Unmodulated, 100 MHz, 10 dBm
 Level VAR STEP 5 dB,
 special function "Non-interrupting level setting"

Test setup: Connect power meter to RF output.

Test: Calibrate the power meter to 0 dB (for relative level measurements) or note the absolute level. Reduce the level on the SMG by 5 dB, 10 dB, 15 dB and 20 dB using the STEP key and check the level jumps on the power meter.

The permissible deviation is:

±0.2 dB at -5 dB
 ±0.5 dB at -10 dB
 ±0.5 dB at -15 dB
 ±0.5 dB at -20 dB

3.2.8 Output Reflection Coefficient

SMG setting: Level 0 dBm, AM EXT 0%,
 frequency 5 to 1000 MHz (measuring example: 5 MHz)

RF analyzer: Center frequency 5 MHz
 Res BW and Video BW 10 kHz
 Span 0 Hz
 Sweep time 30 ms
 Scale linear

Test setup:

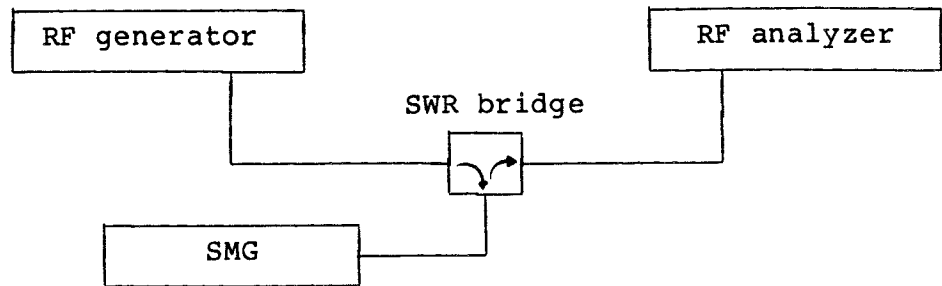

Test:

- Switch off the level on the RF generator (50-Ω output impedance must be maintained).
- Measure the reference level on the RF analyzer and note the result.
- Unscrew the RF cable from the SMG (full reflection). Set a frequency of 5.0001 MHz on the RF generator as well as the level which provides the reference level on the analyzer.
- Reconnect the RF cable on the SMG. With the difference in the frequency of the two generators, the ripple is indicated on the RF analyzer.

Read off the voltages V_{\min} and V_{\max} and calculate the ripple.

$$VSWR = \frac{V_{\max}}{V_{\min}}$$

The ripple must be <1.5.

- Repeat the test with an output level of 2.5 dBm on the SMG. The ripple must be <1.8.

3.2.9 Harmonics

SMG setting: Unmodulated, level 13 dBm, frequency 100 kHz to 1000 MHz

Test setup: Connect RF analyzer to the RF output of the SMG.

Test: Sweep through the output frequency of 100 kHz to 1000 MHz and check the harmonics on the RF analyzer. The harmonic level must not exceed -30 dBc. Ensure that the RF analyzer is not overloaded.

3.2.10 Spurious

SMG setting: Unmodulated, level 0 dBm,
frequency 100 kHz to 1000 MHz

Test setup: Connect RF analyzer to the RF output.

Test: The spurious suppression is preferably tested at
the following frequencies:

Table 3-2

SMG frequency	Search frequency	Spurious suppression
31 MHz	26 MHz 57 MHz 150 MHz 181 MHz	< -70 dBc
195 MHz	150 MHz 169 MHz	< -80 dBc
988 MHz	741 MHz 962 MHz 988.1 MHz	< -70 dBc

3.2.11 SSB Phase Noise

In order to measure the SSB phase noise, the output signal of the SMG is down-converted with a signal of the same frequency from a reference signal generator. The carrier is then rejected and the noise spectrum converted to a low frequency. This low-frequency noise spectrum can be measured using an AF spectrum analyzer.

SMG setting: Unmodulated, level 0 dBm,
frequency 19 MHz (107/481/999.4 MHz)
VAR STEP 1 Hz

Reference generator: Unmodulated, level 7 dBm,
frequency 19 MHz
(107/481/999.4 MHz)

Oscilloscope: DC, 0.1 V/div, triggering AUTO

AF analyzer: Bandwidth 1 kHz, 5 kHz/div

Test setup:

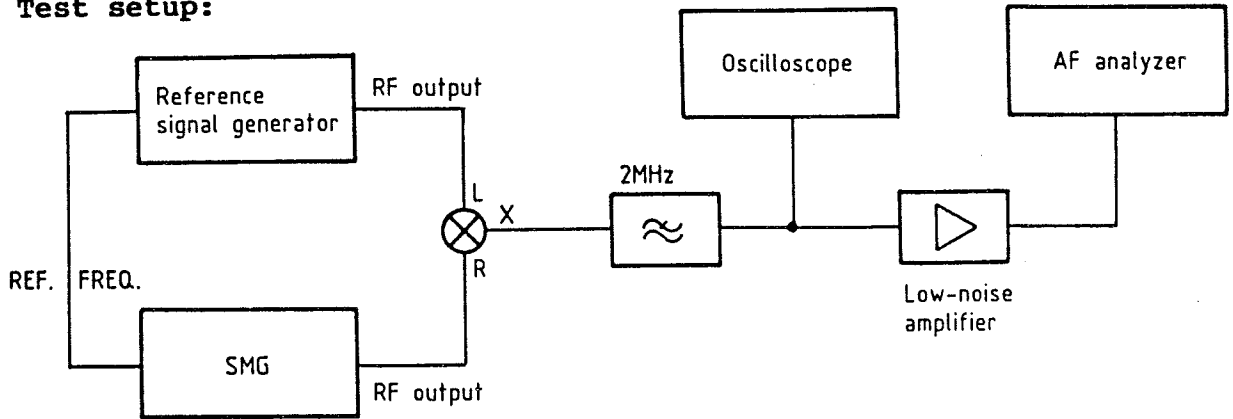

Synchronize the reference frequencies from the SMG and the reference signal generator.

Test:

- a) Set SMG to 19.02 MHz.
Read the reference value on the AF analyzer at 20 kHz.
- b) Set SMG to 19 MHz.
Set a beat of 1 Hz using a step of 1 Hz upwards or downwards and stop the beat with a single step at the zero point on the oscilloscope (± 50 mV). This sets the two input signals of the mixer in the phase quadrature.
- c) Read the noise level on the analyzer at 20 kHz and convert to a 1-Hz bandwidth (if e.g. a bandwidth of 1 kHz is used for the measurement, 30 dB must be subtracted from the measured noise level). Take into account the form factor in the case of analyzers with mean-value rectification.
- d) The SSB phase noise is calculated as follows:

	Example
Measured noise level (1-Hz bandwidth)	-118 dBm
Minus reference level	-(+12 dBm)
Minus 6 dB because 2 side bands are measured	-6 dB
	-136 dBc
	=====

- e) Repeat the measurement at 107 MHz, 481 MHz and 999.4 MHz.

The following values of SSB phase noise must not be exceeded:

Table 3-3

Carrier frequency	SSB phase noise at 20 kHz from carrier
19 MHz	-133 dBc
107 MHz	-137 dBc
481 MHz	-124 dBc
999.4 MHz	-118 dBc

Note: This measurement takes into consideration the SSB phase noise of both generators. The reference signal generator must therefore be at least 10 dB better than the SMG in order to achieve an exact measurement.

3.2.12 Broadband Noise

The carrier of the SMG is attenuated using a filter in order to measure the broadband noise using an RF analyzer.

SMG setting: Unmodulated, level 8.1 dBm, frequency 100 kHz to 1000 MHz

Test setup:

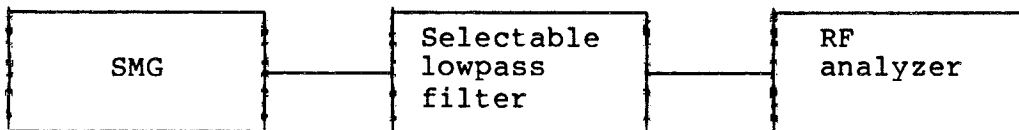

- Test:**
- Set the lowpass filter such that the SMG carrier is attenuated by at least 20 dB.
 - Set the analyzer as sensitive as possible (no pre-attenuation). Measure the noise level in the passband of the filter and convert to a 1-Hz bandwidth. This level, referred to 8.1 dBm, is the broadband noise level.

The broadband noise level must not exceed -140 dBc.

3.2.13 Residual FM

SMG setting: Unmodulated, level 0 dBm,
frequency 20 to 1000 MHz

Test setup:

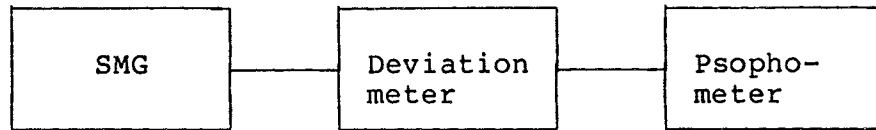

Test: Measure the residual FM with a CCITT weighting filter or unweighted (30 Hz to 20 kHz) and an RMS rectifier.

The following values of the residual FM must not be exceeded:

Table 3-4

Carrier frequency	Residual FM CCITT	Residual FM 30 Hz to 20 kHz
30 MHz	< 2 Hz	< 6 Hz
60 MHz	< 1 Hz	< 4 Hz
120 MHz	< 1 Hz	< 4 Hz
240 MHz	< 1 Hz	< 4 Hz
480 MHz	< 2 Hz	< 6 Hz
1000 MHz	< 4 Hz	< 12 Hz

3.2.14 Modulation Generator

The values in brackets () apply to the SMG-B2 AF Synthesizer option.

SMG setting: AF 40 Hz to 15 kHz (10 Hz to 100 kHz)

Test setup:

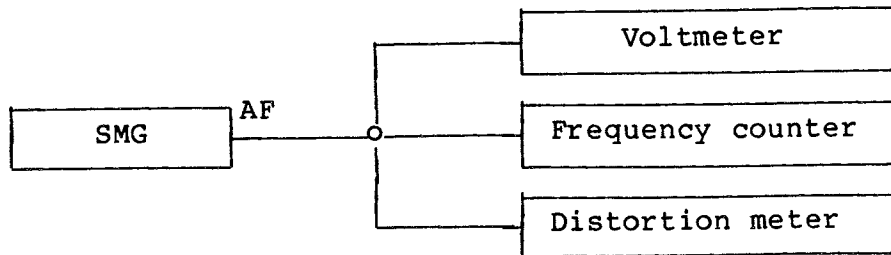

Test: Vary the frequency of the modulation generator from 40 Hz to 15 kHz (10 Hz to 100 kHz) and measure the level, frequency and distortion.

The level at 1 kHz must be 1 V \pm 1%.

The frequency response must not exceed 2% up to 20 kHz and 3% up to 100 kHz.

The frequency error must not exceed 3% (4×10^{-5}).

The distortion at 1 kHz must not exceed 0.1%.

3.2.15 Function Test of the External Modulation Level Monitoring

SMG setting: Level 0 dBm, a) FM EXT 50 kHz
b) AM EXT 80 %

Test setup: Apply a modulation signal of 1 kHz to the modulation input FM or AM.

Test: EXT LOW must light up in the modulation display with an input level of 0.97 V.

EXT HIGH must light up in the modulation display with an input level of 1.03 V.

Neither EXT LOW nor EXT HIGH is to light up with an input level of 0.99 to 1.01 V.

3.2.16 AM Modulation Depth

SMG setting: Level 0 dBm, frequency 0.1 to 1000 MHz,
AM INT 0.5 to 80%, AF 1 kHz

Test setup: Connect modulation analyzer to RF output.

Test: The deviation of the modulation depth from a set value must not exceed 4% of the display +1%.

3.2.17 AM Distortion

SMG setting: Level 0 dBm, frequency 0.1 to 1000 MHz,
AM INT 30% (80%), AF 1 kHz

Test setup: Connect modulation analyzer with distortion meter to RF output.

Test: The distortion must not exceed 1% with 30% AM.

The distortion must not exceed 2% with 80% AM.

3.2.18 AM Frequency Response

SMG setting: Level 0 dBm, frequency 0.1 to 1000 MHz,
AM EXT 80%

Test setup:

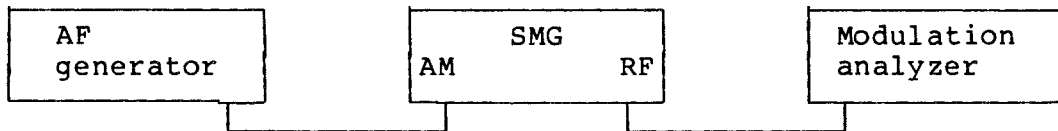

Test: Set a level of 1 V on the AF generator and vary the frequency from 10 Hz to 50 kHz.

The modulation frequency response (30 Hz up to 10 kHz) must not exceed 0.4 dB.

The modulation frequency response (10 Hz up to 50 kHz) must not exceed 1 dB.

3.2.19 AM DC

SMG setting: Level 0 dBm, frequency 1000 MHz,
AM EXT DC 100%

Test setup: Connect RF analyzer to RF output of SMG.

Test: A DC voltage of +1.41 V applied to the AM modulation input must increase the RF level by 5.5 to 6.5 dB.

A voltage of -1.5 V must result in an attenuation of at least 34 dB.

3.2.20 Residual AM

SMG setting: Unmodulated, level 0 dBm,
frequency 0.1 to 1000 MHz

Test setup: Connect modulation analyzer to RF output.

Test: Measure the residual AM unweighted (30 Hz to 20 kHz) and with an RMS rectifier.

Permissible residual AM <0.02%.

3.2.21 Incidental ϕ M at AM

SMG setting: Level 0 dBm, frequency 4 to 1000 MHz,
AM INT 30%, AF 1 kHz

Test setup: Connect modulation analyzer to RF output.

Test: Measure the phase modulation produced at various carrier frequencies.

Permissible incidental ϕ M <0.2 rad.

3.2.22 FM Deviation Setting

SMG setting: Level 0 dBm, frequency 100 MHz,
FM INT 1 to 100 kHz, AF 1 kHz

Test setup: Connect modulation analyzer to RF output.

Test: Measure the FM deviation at the following deviation settings:

1 kHz, 3 kHz, 10 kHz, 30 kHz, 100 kHz

The deviation from the set value must not exceed 5%.

3.2.23 FM Distortion

SMG setting: Level 0 dBm, frequency 64 MHz,
FM INT 50 kHz, AF 1 kHz

Test setup: Connect modulation analyzer with distortion meter to the RF output of the SMG.

Test: The FM distortion must not exceed 0.5%.

3.2.24 FM Frequency Response

SMG setting: Level 0 dBm, frequency 100 MHz,
FM EXT 100 kHz

Test setup: Connect AF generator to modulation input FM. Connect modulation analyzer to RF output.

Test: Set a level of 1 V on the AF generator and vary the frequency from 20 Hz to 100 kHz. The modulation frequency response must not exceed 0.5 dB.

3.2.25 Frequency Offset at FM DC

SMG setting: Level 0 dBm, frequency 100 MHz,
FM EXT DC 0 kHz

Test setup: Connect frequency counter to RF output.

Test: Measure the output frequency with the modulation switched on and off. The difference must not exceed 200 Hz.

3.2.26 Incidental AM at FM

SMG setting: Level 0 dBm, frequency 0.1 to 1000 MHz,
FM INT 40 kHz, AF 1 kHz

Test setup: Connect modulation analyzer to RF output.

Test: Measure the AM produced at various carrier frequencies.

The measured values must not exceed 0.1%.

3.2.27 Φ M Deviation Setting

SMG setting: Level 0 dBm, frequency 100 MHz,
 Φ M INT 0.1 to 10 rad, AF 1 kHz

Test setup: Connect modulation analyzer to RF output.

Test: Measure the Φ M deviation at the following settings:

0.1 rad
0.3 rad
1 rad
3 rad
10 rad

The deviation from the set value must not exceed 5%.

3.2.28 Φ M Distortion

SMG setting: Level 0 dBm, frequency 64 MHz,
 Φ M INT 5 rad, AF 1 kHz

Test setup: Connect modulation analyzer with distortion meter to the RF output of the SMG.

Test: The Φ M distortion must not exceed 0.5%.

3.2.29 ϕ M Frequency Response

SMG setting: Level 0 dBm, frequency 100 MHz,
 ϕ M EXT 10 rad

Test setup: Connect AF generator to modulation input FM/ ϕ M.
Connect modulation analyzer to RF output.

Test: Set a level of 1 V on the AF generator and vary
the frequency from 300 Hz to 10 kHz.

The modulation frequency response up to 10 kHz
must not exceed 1 dB.

3.2.30 Overvoltage Protection

SMG setting: Unmodulated, level -122 dBm,
frequency 100 MHz

Test setup 1: Connect a regulated power supply unit to the RF
output of the SMG via a 50- Ω resistor.

Test: Apply a DC voltage to the RF output. The over-
voltage protection must trip at a voltage of
 ± 10 V.

Test setup 2: Connect a power signal generator with an RF power
output of 0.5 to 2 W to the RF output of the SMG.

Test: Apply a frequency of 25 to 1000 MHz to the RF out-
put. The overvoltage protection must trip at an RF
power of 0.5 to 1 W.

3.2.31 Pulse Modulation

SMG setting: Level 0 dBm, frequency 0.1 to 1000 MHz,
pulse modulation on (special function 29).

Test setup: Connect RF analyzer to RF output of SMG.

Test: A DC voltage of <0.8 V (TTL LOW level) applied to
the PM EXT modulation input or a short circuit of
the input against ground must blank the RF level
by at least 70 dB.

3.3 Performance Test Report

ROHDE & SCHWARZ

Date:

SIGNAL GENERATOR SMG

Name:

Ord. No. 801.0001.52

SER.

Item	Characteristic	Measure as in Section	Min.	Actual	Max.	Unit
1	Function of keypads and displays	3.2.1	--		--	
2	Frequency setting	3.2.2	--		--	
3	Settling time	3.2.4	--		15	ms
4	Output level test level 10 dBm frequency response	3.2.5	--		1	dB
5	Attenuation set error	3.2.6	--		1	dB
6	Non-interrupting level variation Error at -5 dB -10 dB -15 dB -20 dB	3.2.7	-- -- -- --		0.2 0.5 0.5 0.5	dB dB dB dB

Item	Characteristic	Measure as in Section	Min.	Actual	Max.	Unit
7	Output reflection coefficient VSWR at 0 dBm 2.5 dBm	3.2.8	-- --		1.5 1.8	
8	Harmonics at 13 dBm	3.2.9	--		-30	dBc
9	Spurious at 31 MHz 195 MHz 988 MHz	3.2.10	-- -- --		-70 -80 -70	dBc dBc dBc
10	SSB phase noise at 20 kHz from carrier at 19 MHz 107 MHz 481 MHz 999.4 MHz	3.2.11	-- -- -- --		-133 -137 -124 -118	dBc dBc dBc dBc
11	Broadband noise	3.2.12	--		-140	dBc
12	Residual FM, CCITT at 30 MHz 60 MHz 120 MHz 240 MHz 480 MHz 1000 MHz	3.2.13	-- -- -- -- -- --		2 1 1 1 2 4	Hz Hz Hz Hz Hz Hz

Item	Characteristic	Measure as in Section	Min.	Actual	Max.	Unit
	Residual FM (30 Hz to 20 kHz) at 30 MHz 60 MHz 120 MHz 240 MHz 480 MHz 1000 MHz		-- -- -- -- -- --		6 4 4 4 6 12	Hz Hz Hz Hz Hz Hz
13	Frequency error of modulation generator Standard Option AF Synthesizer SMG-B2	3.2.14	-- --		3 4×10^{-5}	% %
14	Modulation generator level	3.2.15	0.99		1.01	V _{rms}
15	Modulation generator distortion at 1 kHz	3.2.14	--		0.1	%
16	AM modulation depth at 1 MHz m = 30% m = 80% 10 MHz m = 30% m = 80% 100 MHz m = 30% m = 80% 1000 MHz m = 30% m = 80%	3.2.16	27.8 75.8 27.8 75.8 27.8 75.8 27.8 75.8		32.2 84.2 32.2 84.2 32.2 84.2 32.2 84.2	% % % % % % % %

Item	Characteristic	Measure as in Section	Min.	Actual	Max.	Unit	
17	AM distortion $f_{\text{mod}} = 1 \text{ kHz}$, $m = 30\%$	3.2.17					
	at 1 MHz		--		1	%	
	10 MHz		--		1	%	
	100 MHz		--		1	%	
	1000 MHz		--		1	%	
	$m = 80\%$						
	at 1 MHz		--		2	%	
	10 MHz		--		2	%	
100 MHz	--		2	%			
1000 MHz	--		2	%			
18	AM frequency response	3.2.18					
	30 Hz up to 10 kHz 10 Hz up to 50 kHz		-- --		0.4 1	dB dB	
19	Incidental ϕM at 30% AM	3.2.21	--		0.2	rad	
20	FM deviation setting	3.2.22					
	at 1 kHz		0.95		1.05	kHz	
	3 kHz		2.85		3.15	kHz	
	10 kHz		9.5		10.5	kHz	
	30 kHz		28.5		31.5	kHz	
	100 kHz		95		105	kHz	
21	FM distortion	3.2.23	--		0.5	%	
22	FM frequency response	3.2.24					
	20 Hz to 100 kHz		--		0.5	dB	
23	Frequency offset at FM DC (100 MHz)	3.2.25	--		200	Hz	

Item	Characteristic	Measure as in Section	Min.	Actual	Max.	Unit
24	FM deviation setting 0.1 rad 0.3 rad 1 rad 3 rad 10 rad	3.2.27	0.095 0.285 0.95 2.85 9.5		0.105 0.315 1.05 3.15 10.5	rad rad rad rad rad
25	FM distortion	3.2.28	--		0.5	%
26	FM frequency response up to 10 kHz	3.2.29	--		1	dB
27	Response threshold of overvoltage protection for RF for DC	3.2.30	23 --		30 10	dBm V
28	ON/OFF ratio with pulse modulation RF = 0,1...2000 MHz	3.2.31	70		--	dB



ROHDE&SCHWARZ

Bilder

Figures

Figures

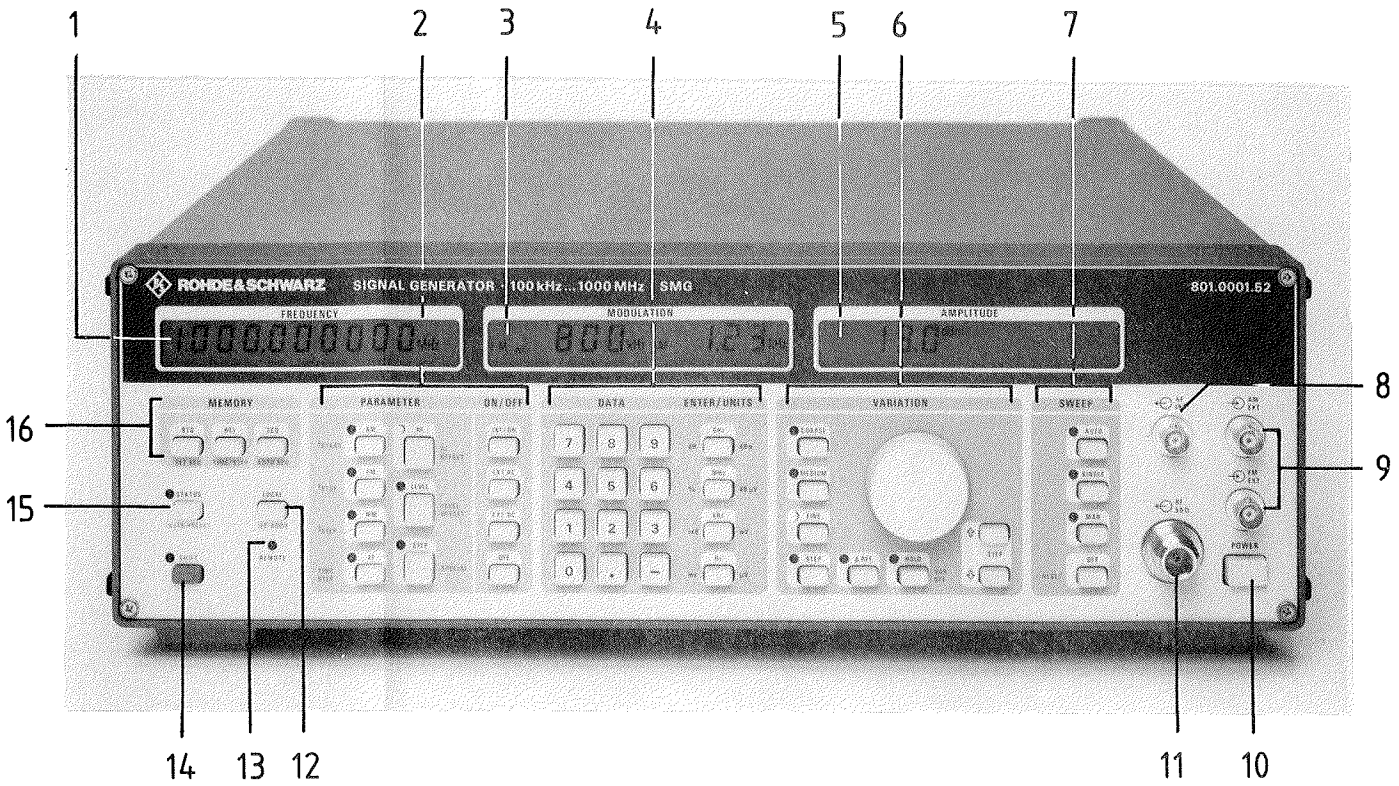

Bild 2-1 Frontansicht
 Fig. 2-1 Front panel

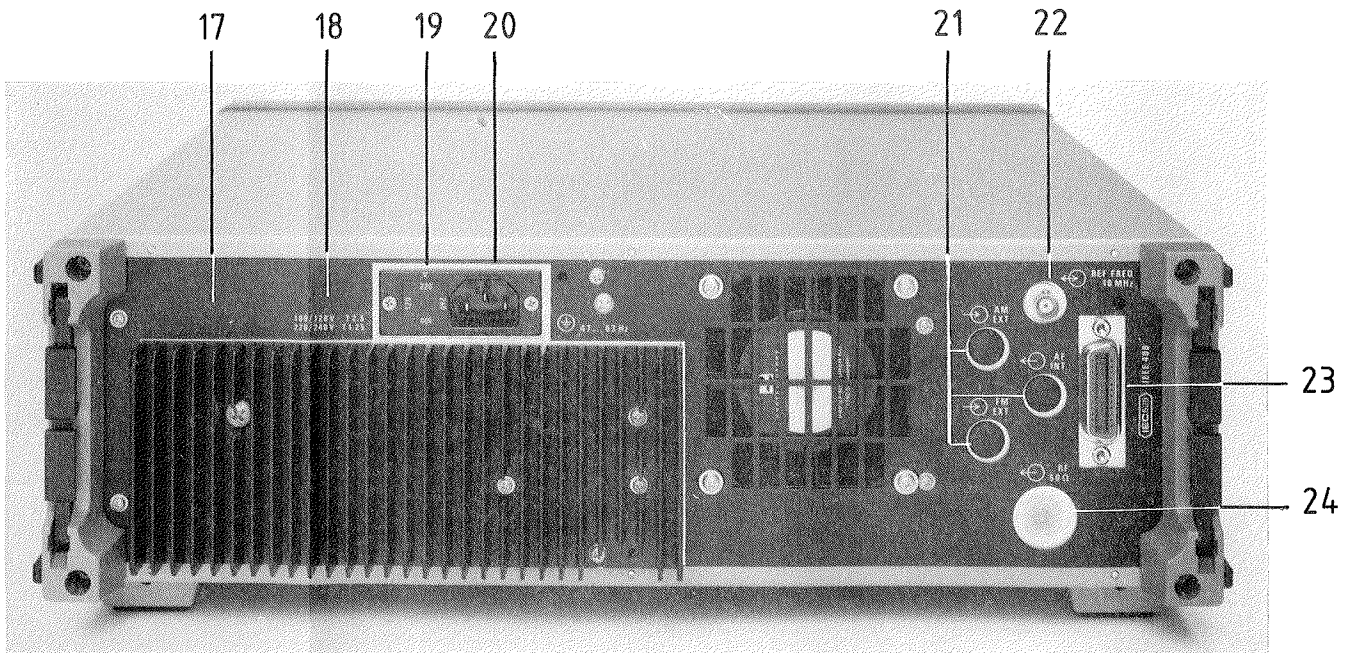

Bild 2-2 Rückansicht
 Fig. 2-2 Rear panel